

Always one step ahead!



No. 19

# · Hager & Werken Dentistry Catalog ·

Dental Products Worldwide



Bambach® Miraject®



**HÄGER  
WERKEN**

# Our team worldwide



Häger & Werken GmbH & Co. KG  
Ackerstraße 1, 47269 Duisburg,  
Germany  
Tel.: +49 (203) 99269-0  
Fax: +49 (203) 299283  
E-Mail: info@hagerwerken.de  
Website: www.hagerwerken.de  
General Manager: Patrick Hager



Hong Kong Office  
Unit 07, 7/F, Block A, New Trade Plaza,  
6 On Ping Street, ShaTin, N.T.  
Hong Kong  
Tel.: +852-2622 2795  
Fax: +852-2622 2503  
E-Mail: info@hagerasia.com.hk  
General Manager: Kate Tsui



Häger Worldwide, Inc.  
441 19<sup>th</sup> Street SE  
Hickory N.C. 28602, USA  
Tel.: +001 (828) 624-3300  
Fax: +001 (828) 624-3303  
E-Mail: contact@hagerworldwide.com  
Website: www.hagerworldwide.com  
General Manager: Mark Schneider



"HÄGER EURASIA" OOO  
127051, Moscow, Russia  
Tsvetnoy bulvard, 30, Bldg. 1  
Tel. / Fax: +7 495 255 0902  
E-Mail: o.seifert@hagerwerken.de  
General Manager: Olga Seifert



Häger Polonia Sp. z o.o.  
Ul. Galczyńskiego 23  
52-214 Wrocław  
Tel.: +48 - 71-368-71-66  
Fax: +48 - 71-368-10-21  
E-Mail: biuro@hager.com.pl  
General Manager: Ania Biernacka-Świenc



HÄGER PHARMA GmbH  
Ackerstraße 1, 47269 Duisburg  
Tel.: +49 (203) 99 269 900,  
Fax: +49 (203) 99 269 999  
E-Mail: info@hager-pharma.de  
Website: www.hager-pharma.de  
General Manager: Klemens Böhm



Patrick Hager,  
General Manager

Michael Hager,  
Senior Adviser



IDS 2019 – our international team

## Always close to our customers

Häger & Werken and its brand miradent have been well-known to dentists, dental technicians and dental professional personnel for more than 70 years. The product catalogue has long been used and kept as a compendium for innovative product specialties. Since 2000 it has also been available online at [www.hagerwerken.de](http://www.hagerwerken.de). In 2017 this service was optimized for cell phones. Our products are constantly checked and new products are only introduced to our range if they offer a clear advantage to available alternatives - true to the motto "always one step ahead!". A new product needs to be quicker and more practical in use and should at best also offer a higher patient comfort.

Häger & Werken offers its products on 6 continents and it is due to our promise of quality that we were able to acquire many new satisfied regular customers over the last two decades. Not only is this promise of quality being attested by annual TÜV audits in accordance with ISO 13458, but this concept is also incorporated in our company. Many customers compliment us on our pursuit of quality with our own products. Being a family-run business, we put particular emphasis on employee training. About 25% of our staff consist of our former trainees, resulting in the personal engagement and professional competence we value in each and every employee. In the end, it is the customer who benefits from it.

We should be grateful for your continued confidence in us in the future and look forward to enriching your everyday work with our innovative products. Your satisfaction is of the utmost importance to us. Please get into direct contact with us for any question, suggestion and criticism – we look forward to hearing from you!

*Patrick Hager*

## Our team – always ready for our customers!

For questions and orders please contact our sales representatives, our sales team in Duisburg or your dental dealer. Detailed and up-to-date information about our products can be found on the Internet at:

[www.hagerwerken.de](http://www.hagerwerken.de) and [www.miradent.de](http://www.miradent.de)



### Our team in Duisburg is available:

**Mon. – Thu. 08:00 – 17:00**

**Fri. 08:00 – 15:30**

**Fon: +49 (203) 99 269 + extension number**

**Fax: +49 (203) 299283**

#### Service Export

Anneli Heyse, [a.heyse@hagerwerken.de](mailto:a.heyse@hagerwerken.de)

- 43

Andreas Götter, [a.goetter@hagerwerken.de](mailto:a.goetter@hagerwerken.de)

- 42

Dirk Seelbach, [d.seelbach@hagerwerken.de](mailto:d.seelbach@hagerwerken.de)

- 47

#### Technical Service

[technischer-service@hagerwerken.de](mailto:technischer-service@hagerwerken.de)

- 61

#### European Sales and Marketing Director

Marcus van Dijk, [m.vandijk@hagerwerken.de](mailto:m.vandijk@hagerwerken.de)

- 16

#### European Sales Manager

Jörg Zensen, [j.zensen@hagerwerken.de](mailto:j.zensen@hagerwerken.de)

+49 (172) 210 72 03

#### Sales Manager Austria/Switzerland

Simone Krug-Trummer, [s.krug@hagerwerken.de](mailto:s.krug@hagerwerken.de)

+43 (664) 150 1417

#### Sales Manager France/Spain/Portugal

Séverine Sánchez, [s.sanchez@hagerwerken.de](mailto:s.sanchez@hagerwerken.de)

+34 (687) 381 020

#### Sales Manager Adriatic Region

Klaudija Primorac, [klaudija@hagerwerken.de](mailto:klaudija@hagerwerken.de)

+385 (98) 997 4678



German headquarters



Hager Worldwide Corporate Office Hickory, North Carolina



Hager Polonia Corporate Office Wrocław (Breslau), Poland

# Index Chapter

## 06 Impression

The new impression tray with patented foil technique is a development of the team of Prof. Dr. Spiekermann (University of Aachen). Implant posts penetrate the foil quickly, clean and with high-precision. Big time and cost savings as no laboratory or 2nd patient impression is needed.

## 10 Application/Injection

Since 1967 Miraject has been standing for leadership and quality. Over 500 million blunt and bendable application canulas with ensured precise and controllable application of liquids and pastes.

## 17 Rubberdam

Excellent quality and long-lasting constant clamp force. Our stainless steel „formula“ ensures high precision, and the clamps adjust individually to the corresponding tooth. We offer all clamps optional in non-reflecting dull black, e.g. ideal for microscopes and loops usage.

## 24 Fillings/Endodontics

Many little helpers save the dentist time while offering additional patient comfort, e.g. our fissure printer for composite fillings, our atraumatic Crown-Click or N2 root canal cement for difficult cases.

## 32 Dental Specialties

Wide range of innovative products such as Reso-Pac, a „self-dissolving plaster‘ in the mouth,“ GapSeal THE prevention against Periimplantitis, Mirahold bite blocks to hold mouths open and many more ...

## 52 Patient Service and Motivation

Our study models educate patients and raise awareness of high quality prosthetic restorations. Additionally we feature a wide range of toys to reward brave, young patients.

## 60 Bambach®

Our saddle seats have often been imitated, but never equaled. More than 16,000 seats relieve back tensions in German dental practices. We would be more than happy to visit your practice for a free demonstration.

## 62 Devices

For over 30 years we have been a reliable partner for modern radio-frequency surgery units. Our LaserHF offers the perfect combination of Laser and RF technology.

## 67 Protection and Hygiene

As a market leader for dental eye protection, we not only emphasize on safety but also on comfort and stylish designs. In addition to our iSpec series we offer face shields and economically priced H&W protective eyewear.

## 76 miradent®

Our prophylaxis home care assortment: A full range from infant to senior care products. In our campaign „Chew against Plaque“ we educate about the benefits of Xylitol e.g. anti-cariogenic effects.

## 97 Lab Products and Small Equipment

For (in-office) labs we offer small devices and consumables. Highly appreciated best sellers are: Occlu Spray, Mirawet mixing liquid, our light curing Speed Labolight and our portable Micromotor Bravo Portable.

## Index Products

Airsonic Absorbo Box	110	Balance Facebow	104	Carebrush supersoft	78	Durotanic Mouth Mirror	36
Airsonic Adapters	110	Balance Mounting Plates	105	Carebrush white	78	Emmenix Film Holder	48
Airsonic Alu-Oxyd	110	Bambach Armrests	61	CC-Shield	73	Emmenix Flap	48
Airsonic Mini Sandblaster	110	Bambach Foot Height Adjuster	61	Chiru-Cleaner	40	Endo N2	31
Algilock	8	Bambach Leather Care Oil	61	Chirurgo-Suc I	40	Fit-N-Fix	39
Algilock Cleaner Plus	9	Bambach OP	61	Clean-Jet Powder	43	Fit-N-Swipe	32
Algilock Partial	9	Bambach Saddle Seat	60	Clip-Clap	45	Fit Rubberdam	
Algilock Pedo	9	Bambach Saddle Seat Cutaway	61	Cold-Bag	37	Cervical Clamp 214	20
Algilock Perforated	8	BD-Steribox	45	Compo Blitz	44	Fit Rubberdam Clamp Board	17
Algiloid	9	B-EX / C-EX	26	Compo-Brush	44	Fit Rubberdam Clamp Forceps	18
Algimix	101	Blue-Flame 1500	108	Contact Gauge	27	Fit Rubberdam Clamps	20
Alminax	98	Bravo Marathon Portable III	106	Corund SC	98	Fit Rubberdam Clamps	22
Alminax Rite-Bite	98	Bravo Portable II	106	Cotton-Clip	39	Fit Rubberdam Clamps	23
Amalgam Well	27	Bravo TD III	106	Cottoroll	39	Fit Rubberdam Clamps Black	20
Anti-Stress Tooth	59	Brillant	36	Crown Click De Luxe	26	Fit Rubberdam	
Apply-Tips	11	Brillant Anti-Fog	36	Cyano Fast / Cyano Retarder	25	Clamps for Children	21
APT Gas	108	Calci-Line	25	Cyano Pipettes	25	Fit Rubberdam Eliot Separator	19
APT III Burner	108	Carat Base Paste	102	Dapp-a-Way	42	Fit Rubberdam Folding Frame	19
Aquamed	76	Carat Biopaque	102	Del-Ject	27	Fit Rubberdam-Latex	18
Artiholder	27	Carat Ecoline	102	Dento Box I	88	Fit Rubberdam Perforating	
Astro Clean	38	Carat Ecoline Enamel	103	Dento Box I + II	53	Template	17
Astro Clean	73	Carat Ecoline Overglaze	103	Desmoclean	31	Fit Rubberdam Punch	18
Balance Articulator	104	Carat Modeling Liquid	103	Dipol	97	Fit Rubberdam Starter Kit I	17
Balance De Luxe Articulator	105	Carebrush ortho	78	Dosing Bottle	44		



Fit Rubberdam Starter Kit II	17	laservision	65	mirasensitive hap <sup>+</sup>	81	Reso-Pac	33
Fit Rubberdam Steel Frame	19	Liftbox	35	Mirasuc Adapter	41	Röntgomarker	49
Fit Rubberdam T-Clamps	21			Mirasuc Brush	40	Rotoprox	43
Flexbrush	39	<b>Mara Expert Charcoal</b>		Mirasucto	41		
Flex-O-Bol	101	Plus Sensitive	112	Miratoi	57 - 59	<b>Salibag</b>	49
Funny Animals	89	Mara Expert Floss sticks	112	Mirator 2000E	101	Skalpell-Ex / Pin-Clipper	40
<b>GapSeal</b>	10	Mara Expert Interdental		Miratorch	109	Solderfix	107
Glas Bead Heater	107	Brushes "Premium Line"	112	Miratray	7	SOS Dentobox	83
Gripit	26	Matrix-Spanner	35	Miratray 3 in 1	6	Spandex	34
<b>Hager iSpec BT Fit</b>	71	McTooth Mirror	53	Miratray 140°	7	Spandex-Vertical	34
Hager iSpec Classic Fit	69	Membranbox Medium	53	Miratray Implant	6	Speed Labolight	107
Hager iSpec Comfort Fit	71	Membranbox Small and XXL	53	Miratray Mini	6	Speedo-Clean	109
Hager iSpec Fit OTG	73	Micro-Etch	25	Miratray Partial	7	Steri-Suc-Tube	40
Hager iSpec Flexi Fit	70	Mira-2-Ton Solution	42 + 86	Miratray Spray	8	Strip Holder	45
Hager iSpec Flexi Fit II	70	Mira-2-Ton Tablets	86	Mirawet	97	Study Model Demo	
Hager iSpec Pure Fit	68	Mirabol	101	Mirawhite gelée	81	Implant C+B	54
Hager iSpec Pure Fit II	68	Mirabrush	11	Mirawhite Laser Bleaching	65	Study Model ORTHO-Brackets	55
Hager iSpec Pure Fit II	68	Miracast	105	Mirawhite shine	80	Study Model Transparent	54
Hager iSpec Safety Fit	69	Mira Clean	44	Mirodent	36	Study Model Transparent	
Hager iSpec Safety Fit II	69	Miraclean-Implant Black	32	Mouth Mirror		Child	55
Hager iSpec Slim Fit	72	Mira-Clin hap	42	Finger-Grip Handle	36	Study Model Transparent	
Hager iSpec Slim Fit UV	72	Miraclin Implant	82	Myzotect-Tincture	47	De Luxe	54
Hager iSpec Softflex Fit	68	Mira-Clin P	42			Study Model Transparent Plus	54
Hager iSpec spectacle wipes	38	Miraclip	38	<b>Non-Stick</b>	98	Super-Splint	24
Hager iSpec Steril Fit	72	Miracold Plus	37	<b>Occlu-Print</b>	28	Super-Splint De Luxe	24
Hager iSpec Steril Fit OTG	72	Mira-Dapp	11	Occlu Spray Plus	27		
Hager iSpec Sunshine Fit	69	miradent Hourglass	88	Occlu Spray Plus	99	<b>Tong-Clin De Luxe</b>	87
Hager iSpec Super Lite Fit	71	miradent Mouth Mirror	85	Orange Solvent	37	Tong-Clin Gel	87
Hager iSpec X Fit	70	Miradont-Gel	33	Orbatec	111	Toothbrushing Model	55
Hager Outbacks	67	Mira-Duo	53	Orbatec Holder	111	Tooth Coin Bank	59
halitosis spray	86	Mirafit 3in1	29	Orbatec Prophy	111	Twin-Pipette	45
Happy Morning	79	Mirafit BC	28	OXYSAFE Gel Professional	50		
Happy Morning De Luxe	79	Mirafit Carbon and White	29	OXYSAFE Liquid Professional	50	<b>Variator-Kit</b>	35
Happy Morning Travel Kit	79	Mirafit Core	28			Vernax 100	99
Happy Morning Xylitol	79	Mirafloss	82	<b>Panascope</b>	49	Vernax Collodial Graphite	99
hf1 Surg bipolar	63	Mirafloss Big	82	Parallelometer-Mirror	37	Vernax S / Vernax G	99
hf Bipolar-Forceps	64	Mirafloss Implant chx	82	paroguard	80	Vernax Thinner	99
hf Electrodes	64	Mirafluor C	81	Pelotte-Aspirator	41	<b>X-Ray Stain Remover</b>	49
hf Neutral Electrode	64	Mirafluor chx	80	Pelotte Plus	41	XyliPOP Lolli	76
hf Surg	63	mirafluor-gel / k-gel	46	Perfect Splint C	24	Xylitol Chewing Gum	77
H&W Classic	74	Mirafluorid	46	Perfect Splint-System	24	Xylitol Chewing Gum for Kids	77
H&W Featherlight	74	Mirafluor-Tray	46	PerioMarker	47	Xylitol Drops	77
H&W Kids Protect	74	Miraglu	32	Pic-Brush Intro Kit	84	Xylitol Powder	76
H&W Logic	75	Mirahold	34	Pic-Brush Replacement Brushes	84		
H&W OTG II	75	Mirahold-Block	34	Pic-Brush Set	84	<b>Zahnpick</b>	83
H&W Panorama	74	Miraject	15	Pick up Stick	47		
H&W Panorama II	75	Miraject Endo Luer	13	Plantana	52		
H&W Sports Pro	75	Miraject Endo Rinse	13	Plaque Agent	89		
H&W Super Fit UV (OTG)	75	Miraject Endotec Duo	14	Plaque Check	86		
		Miraject Endotec Luer	14	Praxipolish Plus	38		
<b>Infant-O-Brush</b>	88	Miraject Flexi Tip	14	Praxipol PS II	100		
Integra Cart De Luxe I - III	66	Miraject Luer	15	Prophy-Angles	43		
Integra Cart Fit-On Tray	66	Miraject PL Super	13	Prophy-Cup	43		
Integra Cart Smart	66	Miraject P / P Super	13	Prophy-Ring	42		
I-Prox Care Set	85	Miralay	35	Prosonic micro 2	78		
I-Prox L	83	Miramask	39	Protectoray	48		
I-Prox P	85	Miramatic	16	Protho Box	87		
		Miramatic-Box	16	Protho Brush De Luxe	87		
<b>Kid's Brush</b>	89	Miramatic Holder	15	Protho Clean	109		
Kisag Burner	108	Miramatic Holder Plus	15	Proto-Cam	73		
Koni-Cast	105	Mirapont	100	Putzi-Buddys	56		
		Mirapont Agent Plus	100	Putzi-Pets	56		
<b>LaserHF</b>	62	Mirapont Silifit	100				
LaserHF PDT Solutions	65	Mirapor	97	<b>Reflect-Rhod</b>	37		
		Mirapost	30				



Often requires laborious adaptation



Perfect fit

## Miratray® Implant

### Implant impression tray with patented foil technique

- Saves you and your patient an additional patient visit and laboratory costs
- Controllable and safe impression taking with clear view of implant posts
- As foil meets precisely at implant posts, a clean impression is taken
- No overflowing impression material
- Customizable, user-friendly and cost-effective
- Available in three sizes for maxilla and mandible (dentulous and edentulous)
- Suitable for all implant impression materials and implant systems

"Making an individual tray in laboratory is no longer necessary = time saving (appointment) and cost saving for the patient."  
Petra Weidenmüller, Magdeburg

Article description	Size	Content	REF
Intro Kit 6 x 1 piece (Upper/Lower small, medium, large)		6 pcs.	101 250
Upper, S1	small	6 pcs.	101 251
Upper, S2	medium	6 pcs.	101 252
Upper, S3	large	6 pcs.	101 253
Lower, I1	small	6 pcs.	101 254
Lower, I2	medium	6 pcs.	101 255
Lower, I3	large	6 pcs.	101 256

## Miratray® 3 in 1

### 3 work steps in one – impression, counter impression, bite registration

- Time saving: A double impression is taken (upper jaw and lower jaw) in just one step
- Material savings: Partial impression with direct correlation of the occlusion
- Patient-friendly: Faster and less gag reflex
- Sheer, tearproof net material
- Dimensionally stable with strengthened handle
- Color-coded



Article description	Content	REF
Posterior, green	36 pcs.	101 270
Quadrant, yellow	36 pcs.	101 271
Anterior, purple	32 pcs.	101 272
Full Arch, blue	28 pcs.	101 273

## Miratray® Mini

### For single impressions of crowns and small bridges

- Inexpensive disposable plastic tray
- Can easily be slid onto corrugated tweezers
- Excellent for patients, avoids gag reflex
- Saves impression material



Article description	Content	REF
Miratray Mini	50 pcs.	101 102

## Miratray® Partial

### Partial plastic impression tray in three shapes

- Excellent for patients feeling an urge to gag
- Saves impression material

Article description	Content	REF
Bag, PR right	12 pcs.	101 178
Box, PR right	100 pcs.	101 148
Bag, PL left	12 pcs.	101 176
Box, PL left	100 pcs.	101 146
Bag, PM middle	12 pcs.	101 177
Box, PM middle	100 pcs.	101 147
Assortment II, all 3 shapes assorted	100 pcs.	101 151

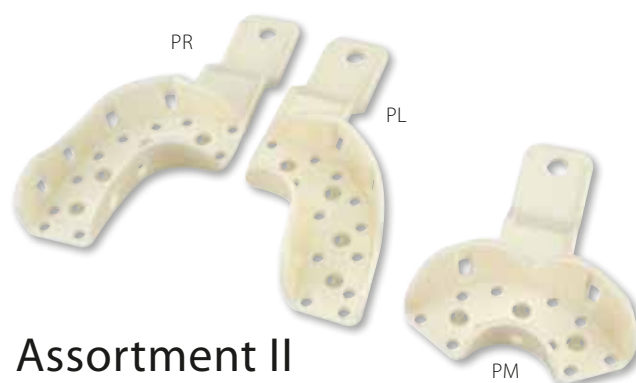

### Assortment II

100 partial trays in three shapes, assorted:  
 Shape: PL PR PM  
 Quantity: 33 33 34

## Miratray®

### Disposable impression tray made of white plastic

- Inexpensive and solid
- Excellent retention of the impression material by special "retention baskets"
- Practical: can be labelled with felt-tip pen
- Complete tray available in three sizes (s, m, l)

Article description	Size	Content	REF
Upper, S1	small	50 pcs.	101 140
Upper, S2	medium	50 pcs.	101 141
Upper, S3	large	50 pcs.	101 142
Lower, I1	small	50 pcs.	101 143
Lower, I2	medium	50 pcs.	101 144
Lower, I3	large	50 pcs.	101 145
Upper, S1	small	12 pcs.	101 170
Upper, S2	medium	12 pcs.	101 171
Upper, S3	large	12 pcs.	101 172
Lower, I1	small	12 pcs.	101 173
Lower, I2	medium	12 pcs.	101 174
Lower, I3	large	12 pcs.	101 175

S = Superior, I = Inferior

Assortment I, assorted	50 pcs.	101 149
------------------------	---------	---------

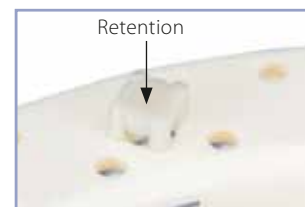

### Assortment I

50 complete/partial trays in nine designs, assorted:  
 Shape: I2 S2 S3 S1 I1 I3 PL PR PM  
 Quantity: 10 10 5 5 5 5 3 3 4

## Miratray® 140°

### Autoclavable plastic impression tray

- Transparent and sturdy
- High retention of the impression material is obtained by special "retention baskets"
- Practical: can be labelled with felt-tip pen
- Available in three sizes (s, m, l)

Article description	Size	Content	REF
Set assorted (3 x each upper and lower jaw)		6 pcs.	101 155
Upper, AS 1	small	6 pcs.	101 156
Upper, AS 2	medium	6 pcs.	101 157
Upper, AS 3	large	6 pcs.	101 158
Lower, AI 1	small	6 pcs.	101 160
Lower, AI 2	medium	6 pcs.	101 161
Lower, AI 3	large	6 pcs.	101 162

AS = Autoclavable Superior AI = Autoclavable Inferior





## Miratray® Spray

### Adhesive spray

- Ideal spray bonding agent for impression trays
- For better adhesion of the impression material to both, plastic and metal trays
- Use only in combination with impression material

Article description	Content	REF
Miratray Spray	200 ml	554 210

## Algilock

### Extremely durable impression tray

- “Retention rims” hold the impression material without adhesives
- Laser-welded handles and ridges for a solid interconnection
- For dentulous jaws
- High-quality, corrosion-resistant stainless steel
- High durability, highest shape stability and long-term good appearance
- Autoclavable without loss of quality
- Only Algilock offers such a unique model variety and solid top quality
- On request, Algilock is available for maxilla and mandible as:
  - Algilock partial (perforated/non-perforated)
  - Algilock pedo (orthodontology)
  - Algilock edentulous (perforated)

Article description	Size	USA	REF
Upper, BS 5	xx-large	U11	101 006
Upper, BS 3	x-large	U12	101 004
Upper, BS 2A	large	U13	101 042
Upper, BS 2	medium	U14	101 003
Upper, BS 1	small	U15	101 002
Lower, BI 5	xx-large	L11	101 011
Lower, BI 3	x-large	L12	101 009
Lower, BI 2A	large	L13	101 043
Lower, BI 2	medium	L14	101 008
Lower, BI 1	small	L15	101 007
Set with 10 trays (5 upper, 5 lower)			101 001

BS = Dentulous Superior BI = Dentulous Imperior

## Algilock Perforated

### Perforated impression tray

- For dentulous jaws
- High-grade corrosion resistant stainless steel
- Top quality, long lasting, brilliant finish and form stability
- Retention rims hold impression material - no adhesive necessary
- Laser-welded handles and palatine ridge
- Autoclavable without affecting finish

Article description	Size	USA	REF
Upper, PS 6	x-large	7	101 036
Upper, PS 5	large	5	101 034
Upper, PS 4	medium	4	101 033
Upper, PS 3	small	1	101 032
Lower, PI 6	x-large	24	101 041
Lower, PI 5	large	22	101 039
Lower, PI 4	medium	21	101 038
Lower, PI 3	small	20	101 037
Set with 8 trays (4 upper, 4 lower)			101 031

PS = Perforated Superior PI = Perforated Imperior





## Algilock Partial

### Partial impression trays / half trays

- For dentulous jaws
- High-grade corrosion resistant stainless steel
- Top quality, long lasting, brilliant finish and form stability
- Retention rims hold impression material - no adhesive necessary
- Laser-welded handles and palatine ridge
- Autoclavable for many years without affecting finish

Article description	REF
Set PR and PL unperforated	101 030
Separate, right PPR perforated	101 044
Separate, left PPL perforated	101 045



## Algilock Pedo

### Perforated orthodontic trays - small

- For dentulous jaws, especially for pediatric dentistry

Article description	REF
Lower, PI 2	101 046
Upper, PS 2	101 047



## Algiloid®

### Highly precise hydro impression material

- Favorable alternative to silicone impressions
- The tray remains in the mouth for only approx. 3 min.
- Easy and quick handling
- Environmental-friendly disposal with household waste
- Combines the advantages of agar hydrocolloid with those of alginate
- Canula tips (package of 2) available separately upon request

#### Highly precise, inexpensive and time-saving impressions with the Algiloid System

The Algiloid system consists of algiloid hydro material as "light body" and customary alginate as "heavy body". Material must be used pre-warmed.

Article description	REF
Box of 48 cylinder ampoules	101 401
Algiloid syringe III, incl. 2 attachments	101 405



## Algilock Cleaner® Plus

### Alginate remover

- Cleaning in dipping bath without mechanical impact, no ultrasound, no scratching
- Decomposes the organic structure of the impression material, no aggressive or caustic effect, no corrosion
- Even after several cleanings impression trays do not tarnish
- Bio-degradable and pH-neutral, phosphate-free, pleasant smell
- For approx. 500 trays

Easily removes plaster and alginates from impression trays, instruments and spatulas. No laborious and time-consuming cleaning, simply add 50 g to 1 l of warm water and leave for approx. 15 – 30 minutes. May also be used in an ultrasonic unit. Not suitable for aluminum trays.

Article description	Content	REF
Algilock Cleaner Plus	1000 g	554 104



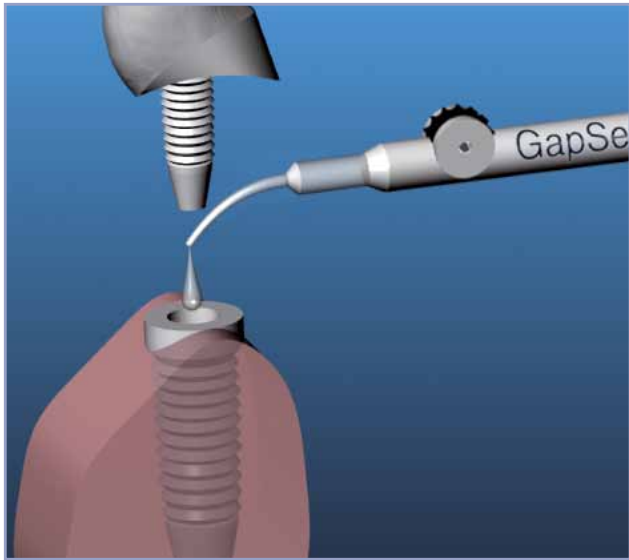

Video

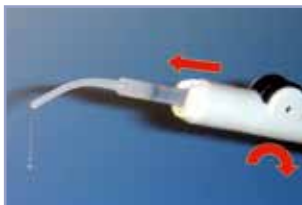

After removal of the closure cap, GapSeal can directly be applied by simply turning the transport screw.

Immediately after the application, the implants are generously loaded with GapSeal. The implant gets sealed airtight with GapSeal, leaving no hollow spaces, by inserting the locking screw.

## GapSeal®

### The decisive weapon against peri-implantitis

- Seals implant gaps and hollow spaces
- Durably stops infiltration of germs into the hollow spaces
- Eliminating risk of re-infection of peri-implant tissue
- Effectively avoids a main reason for peri-implantitis
- Successful over 20-year clinical study of the University Düsseldorf, Germany
- Quick and easy handling and application

Article description	REF
GapSeal Set (applicator with 10 Tips)	152 041
GapSeal Refill Pack (10 Tips à 0,06 ml)	152 040
Applicator separately	152 042

#### Gap Sealing against Peri-implantitis

Out of manufacturing constraints, gaps and hollow spaces between implant and superstructures are inevitable in all compound implants.

These gaps can be minimized depending on fabrication precision. However, they are never completely bacteria-proof and in an open connection with the bacteria-, fungi- and virus settled oral cavity. The spectrum of germs settling in the hollow spaces consists of a large quantity of gram-negative, mostly anaerobic bacteria, as it is the case with peri-implantitis. These humid and warm implant interiors offer an ideal milieu for the growth of bacteria and partly also cause fungi and virus affection. Already 20 years ago, at the Clinic for Oral and Maxillofacial Surgery of the Heinrich-Heine University, Düsseldorf, Germany under the direction of Prof. Dr. Dr. Fritzemeier it was begun to find a solution to this problem. The gap between abutment and implant averages „only“ 45 microns, whereas most of the relevant germs have a size of between 0.5 microns and 4 microns.

Based on extensive studies and tests, a material was developed sealing all capillary gaps and interior spaces of the compound implant bacteria-proof.

GapSeal is based on a special silicone matrix ingredient composition, which creates a barrier effectively preventing infiltration and colonization by bacteria. It is used immediately after inserting the implant with the first fixing of the locking screw. Therefore, the implant is durably protected against colonization by bacteria, viruses and fungi from the very beginning. GapSeal is most easy in application as the material is offered in small portion carpules, together with a special applicator.

GapSeal seals the gaps and hollow spaces, which are to be found in every compound implant, thus effectively and durably avoiding colonization of germs into these hollow spaces and eliminating the risk of re-infection/microleakage of the peri-implant tissue, one of the main reasons for peri-implantitis.

#### Properties of GapSeal:

- Lasting, hermetic protection, no formation of micro-gaps
- Prevents micro leakage
- Ideal for assembled implants
- Gentle to the tissue
- Highly viscous, transparent material (silicone matrix)

## Mira-Dapp

### Disposable dappen container with blue tray

- Economic use of expensive materials
- Protection against evaporation and light
- With the paintbrush submerged, bond does not set for up to 24 hours
- Hygienic, neat and space-saving
- Several liquids can be placed on the tray at the same time
- Applicator stands upright in the container
- Blue tray is autoclavable

Article description	Content	REF
Mira-Dapp, Set	250 pcs. + 1 tray	605 465
Mira-Dapp, Tray separately		605 466



## Apply-Tips®

### Fine application tips

- For precise application of liquids and pastes
- Bendable ends for hard-to-access areas
- Economic use of expensive materials (such as bondings, medicaments, etc.)
- Acid-resistant against bonding and other materials
- Hygienic dispenser box for single removal
- Available in three sizes

Article description	Content	REF
Medium (regular), blue handle	100 pcs.	605 510
Medium (regular), blue handle	5x100 pcs.	605 511
Fine, white handle	100 pcs.	605 512
Fine, white handle	5x100 pcs.	605 513
Conical, green handle	100 pcs.	605 514
Conical, green handle	5x100 pcs.	605 515



## Mirabrush®

### Bendable application brush

- One-piece disposable brush
- Bendable: can be bended into any angle
- Time-saving: no changing of brushes
- Safe: no danger of cross infection
- Yellow handle = pointed brush, exact application
- Blue handle = flat brush, surface application





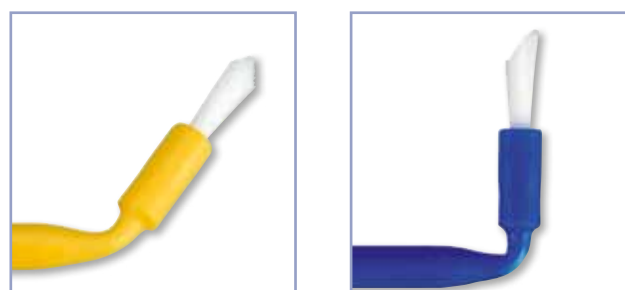



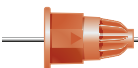

#### Dispenser pack

Article description	Content	REF
Regular 10 cm, yellow/pointed	100 pcs.	605 460
Regular 10 cm, blue/flat	100 pcs.	605 461













• APPLICATION •

 Standard

<b>Miraject P (Carpule)</b> REF 254 206		0.8 x 25 mm/21G	
<b>Miraject P Super (Carpule)</b> REF 254 207		0.9 x 32 mm/20G	
<b>Miraject PL Super (Luer)</b> REF 254 214		0.9 x 22 mm/20G	
<b>Miraject Endo Luer</b> REF 254 222		0.3 x 40 mm/30G	
<b>Miraject Endo Luer</b> REF 254 215		0.5 x 40 mm/25G	

 Endotec Luer













<b>Miraject Endotec Luer</b> REF 254 216		0.8 x 25 mm/21G	
<b>Miraject Endotec Luer</b> REF 254 217		0.6 x 25 mm/23G	
<b>Miraject Endotec Luer</b> REF 254 218		0.5 x 25 mm/25G	
<b>Miraject Endotec Luer</b> REF 254 228		0.4 x 25 mm/27G	
<b>Miraject Endotec Luer</b> REF 254 219		0.3 x 25 mm/30G	

 Endotec Luer Duo









<b>Miraject Endotec Duo</b> REF 254 230		0.6 x 25 mm/23G		<b>Miraject Endotec Duo</b> REF 254 232		0.4 x 25 mm/27G	
<b>Miraject Endotec Duo</b> REF 254 231		0.5 x 25 mm/25G		<b>Miraject Endotec Duo</b> REF 254 233		0.3 x 25 mm/30G	

• INJECTION •

 Carpule  
3 x Schliff

<b>Miraject 17/42</b> REF 254 200		0.5 x 35 mm	
<b>Miraject 17/23</b> REF 254 201		0.5 x 21 mm	
<b>Miraject 30/42</b> REF 254 202		0.4 x 35 mm	
<b>Miraject 30/23</b> REF 254 203		0.4 x 21 mm	
<b>Miraject 40/23</b> REF 254 204		0.3 x 21 mm	
<b>Miraject 40/10</b> REF 254 205		0.3 x 10 mm	

 Luer

<b>Miraject Luer 17/42</b> REF 254 210		0.5 x 42 mm	
<b>Miraject Luer 17/23</b> REF 254 211		0.5 x 23 mm	
<b>Miraject Luer 30/42</b> REF 254 212		0.4 x 42 mm	
<b>Miraject Luer 30/23</b> REF 254 213		0.4 x 23 mm	

**50 years**  
of highest quality



## Miraject® P / P Super

### Canula for paste-like materials

- Blunt, bendable and individually sterile packed
- For cylinder ampoules
- Color-coded

Pack with 100 pieces

Article description	∅	Gauge	Length	REF
Miraject P	0.8 mm	21	25 mm	254 206
Miraject P Super	0.9 mm	20	32 mm	254 207

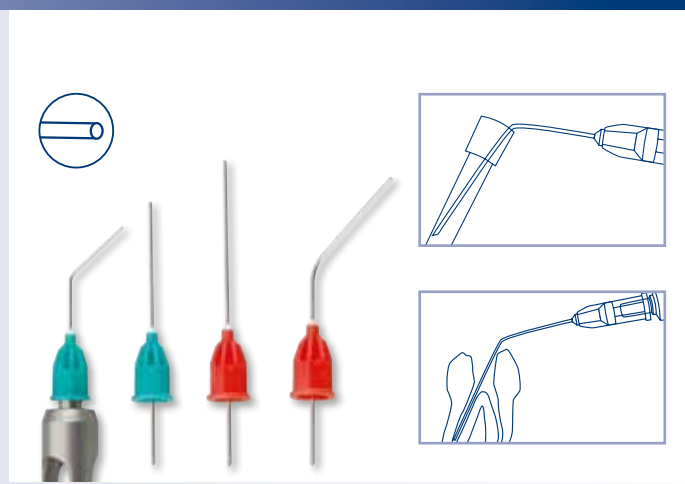

## Miraject® PL Super

### Short blunt Luer application canula

- For application of liquids, gels and for rinsing wider root canals
- Sterile packed
- Bendable
- For syringes with Luer tip

Pack with 100 pieces

Article description	∅	Gauge	Length	REF
Miraject PL Super	0.9 mm	20	22 mm	254 214



## Miraject® Endo Luer

### Long blunt Luer application canula

- Application of liquids and pastes into the root canal
- Finest controllable measures
- In two sizes: 0.3 mm (30 gauge) and 0.5 mm (25 gauge), easy-to-insert into the root canal
- For syringes with Luer tip
- Color-coded

Pack with 100 pieces

Article description	∅	Gauge	Length	REF
Miraject Endo Luer, fine	0.3 mm	30	40 mm	254 222
Miraject Endo Luer, medium	0.5 mm	25	40 mm	254 215



## Miraject® Endo Rinse

### Convenient rinsing system for root canals, etc.

- Consisting of disposable syringe and blunt canula, sterile packed
- Syringe: for 3 ml liquid, with 1/10 ml calibration
- Canula: blunt, fine, long and bendable canula (0.5 mm/25 G x 32 mm)

Pack with 50 disposable syringes and 50 canulas

Article description	∅	Gauge	Length	REF
Miraject Endo Rinse	0.5 mm	25	32 mm	254 220



50 + 50



## Miraject® Endotec Luer

### Special canula for rinsing with lateral opening

- Extra gentle, effective rinsing process
- Lateral opening avoids pressure on the apex
- Round canula end – low perforation risk
- Also ideal for gentle rinsing of periodontal pockets
- Sterile packed
- For syringes with Luer tip
- Color-coded



Pack with 25 pieces

Article description	ø	Gauge	Length	REF
Miraject Endotec Luer	0.8 mm	21	25 mm	254 216
Miraject Endotec Luer	0.6 mm	23	25 mm	254 217
Miraject Endotec Luer	0.5 mm	25	25 mm	254 218
Miraject Endotec Luer	0.4 mm	27	25 mm	254 228
Miraject Endotec Luer	0.3 mm	30	25 mm	254 219



## Miraject® Endotec Duo

### Special canula with two lateral openings

- Extra gentle, effective rinsing process
- Two lateral openings avoid pressure on the apex
- Round canula end – low perforation risk
- Also ideal for gentle rinsing of periodontal pockets
- Sterile packed
- For syringes with Luer tip
- Color-coded

Pack with 25 pieces

Article description	ø	Gauge	Length	REF
Miraject Endotec Duo	0.6 mm	23	25 mm	254 230
Miraject Endotec Duo	0.5 mm	25	25 mm	254 231
Miraject Endotec Duo	0.4 mm	27	25 mm	254 232
Miraject Endotec Duo	0.3 mm	30	25 mm	254 233



Miraject Flexi Tip 21G  
ø 0.6 – 0.8 mm x 24 mm

Miraject Flexi Tip 27G  
ø 0.2 – 0.4 mm x 20 mm

## Miraject® Flexi Tip

### Application tips with Luer-Lock

- Blunt plastic needle pre-bent tip
- Very flexible and form stable
- For exact application and dosing of highly fluid pastes and liquids
- Single use only

Article description	REF
Miraject Flexi Tip Intro Kit (3 syringes 21G à 1 ml and 10 single use tips)	254 240
Miraject Flexi Tip 21G, ø 0.6 – 0.8 mm x 24 mm (25 single use tips) medium	245 241
Miraject Flexi Tip 27G, ø 0.2 – 0.4 mm x 20 mm (25 single use tips) fine	254 242

## Miraject®

### THE injection canula on the dental market

- The classic disposable canula for cylinder ampoules
- Has been the hallmark of quality for more than 50 years: over 400 million Miraject canulas meeting highest quality standards
- Manufactured under strictest quality controls
- Meets the highest requirements of injection hygiene, every needle is equipped with a sterility control seal
- Triple lancet cut – almost painless
- Injection mark – orientation
- Silicone coating – ideal gliding behaviour

#### Pack with 100 pieces

Article description	ø	Gauge	Length	REF
Miraject 17/42	0.5 mm	25	35 mm	254 200
Miraject 17/23	0.5 mm	25	21 mm	254 201
Miraject 30/42	0.5 mm	27	35 mm	254 202
Miraject 30/23	0.4 mm	27	21 mm	254 203
Miraject 40/23	0.3 mm	30	21 mm	254 204

Short canula for intraligamentary anaesthesia (not suitable for the Miramatic system):

Article description	ø	Gauge	Length	REF
Miraject 40/10	0.3 mm	30	10 mm	254 205

## Miraject® Luer

### Injection canula with plastic Luer cone

- For injection solutions from an ampoule
- For any conventional disposable syringe
- Individually and sterile packed
- Color-coded

#### Pack with 100 pieces

Article description	ø	Gauge	Length	REF
Miraject Luer 17/42	0.5 mm	25	42 mm	254 210
Miraject Luer 17/23	0.5 mm	25	23 mm	254 211
Miraject Luer 30/42	0.4 mm	27	42 mm	254 212
Miraject Luer 30/23	0.4 mm	27	23 mm	254 213

## Miramatic® Holder Plus

### Solid safety stand for injection syringes and rinsing canulas

- No risk of injury from needles lying open on the cart
- One-hand re-capping reduces injury risk
- Syringe sits upright in its own protective cover
- Fixing clamp holds the protective cover tightly
- Stainless steel, approx. 240 g

**Tip:** Perfect complement to the Miramatic system

Article description	REF
Miramatic Holder Plus	355 466
Miramatic Holder	355 465

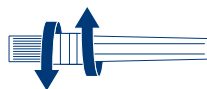

With paper seal

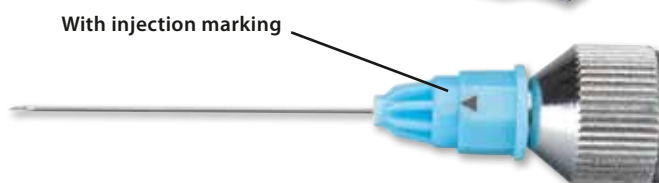

With injection marking



## Miramatic® Holder



- Syringe sits upright in its own protective cover
- 200 g of safe stability
- Stainless steel, autoclavable

plopp

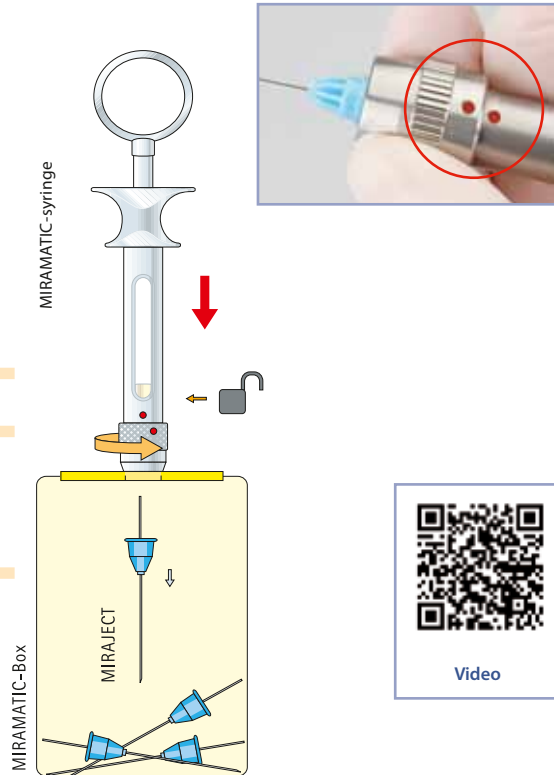

Video

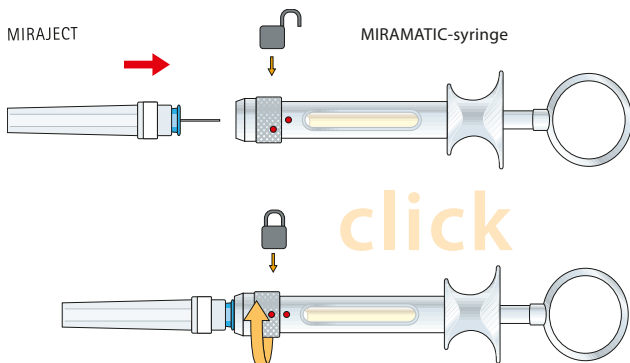

Content: 2.1 l



## Miramatic®

### Innovative safety syringe system with single-handed operation

- “No-touch system”: No risk for the dentist and assistant to come into direct contact with blood- and saliva-contaminated needles
- No risk of infection with HIV, hepatitis and other germs because of “re-capping” or disposing used canulas
- No injury risk from used canulas
- No screwing on and off necessary, more than 70% time saving

Further information on [www.miraject.de](http://www.miraject.de)

**The Miramatic Safety-Set:** 1 syringe, 3 boxes, 1 table fixing device and 1 Pack of Miraject-needles (Typ 30 / 23)

Article description	REF
Set with 1-ring syringe	355 471
Set with 3-ring syringe	355 469
Set with T-handle syringe	355 473

“The “No-touch-system” has convinced me. In our practice we have been familiar with the risk of getting into contact with blood- and saliva contaminated needles for many years and have reduced the risk of infection to a minimum. Following the injection, the safety stand ensures that the syringe is on hand and can be disposed of contact-free + stored safely after use.”

Dr. Gabriele Schmeichel, Lückstedt



**Makes it easy to adhere to the EU-Directive 2010/32/EU regarding prevention of injuries caused by sharp/pointed instruments.**

## Miramatic®-Box

### Patented disposal box

- With automatic lid, opening itself at the push of a button
- Disposal of used canulas and other products contaminated with blood and saliva, such as scalpels, disposable syringes and suchlike
- Absolutely safe storage due to firmly fixed lid with safety lock
- Opening for unlocking the Miramatic syringe and for disposal of the Miraject canulas
- The opening can be enlarged gradually by pushing out the flap
- Table fixing device for firm placing of the box

Article description	REF
5 boxes, 1 table fixing device	355 468
Table fixing device, separately	355 472



## Fit® Rubberdam Starter Kit I

Basic equipment no. I for rubber dam technique

- 1 Board with 12 clamps complete
- 1 Pair of Fit clamp forceps
- 1 Fit punch
- 1 Fit steel frame large
- 1 Fit Rubberdam 30-page booklet

## Fit® Rubberdam Starter Kit II

Basic equipment no. II for rubber dam technique

- 1 Board with 12 clamps complete
- 1 Pair of Fit clamp forceps
- 1 Fit punch
- 1 Fit latex medium (36 sheets)
- 1 Fit folding frame (plastic)
- 1 Perforated template
- 1 Fit Rubberdam 30-page booklet

Article description	REF
Fit Rubberdam Starter Kit I	355 320
Fit Rubberdam Starter Kit II	355 338



## Fit® Rubberdam Clamp Board

Clamp board available with and without clamps

### Stainless steel board, with 8 clamps

2 x No. 9, 1 x each: Nos. 2A, W2A, 5, 56, 203, 204

### Stainless steel board, with 12 clamps

1 x each: Nos. 5, 7, 56, 201, 202, 206, 207, 210, 211, 0, 2, 2A

### Stainless steel board, with 18 clamps

1 x each: Nos. P1, P2, 18, 22, 27, 29, 200, 201, 202, 203, 204, 205, 208, 209, 138, 139, 210, 211

Article description	REF
Clamp Board with 8 clamps	355 330
Clamp Board with 12 clamps	355 331
Clamp Board with 18 clamps	355 332
Clamp Board without clamps (for 8 clamps)	355 327
Clamp Board without clamps (for 12 clamps)	355 328
Clamp Board without clamps (for 18 clamps)	355 329



## Fit® Rubberdam Perforating Template

For marking the holes in rubber dam prior to perforation

- Solid plastic

Article description	REF
Fit Rubberdam Template, 15 x 15 cm	355 318





## Fit® Rubberdam Clamp Forceps

For smooth grasp of the clamps

- Arbitrarily fixable
- No tilting of clamp
- Length: 17 cm

Article description	REF
Fit Rubberdam Clamp Forceps	355 333



## Fit® Rubberdam Punch

For perfectly punched, tearproof perforations

- Movable punching pin constantly using the whole cutting border
- Made of stainless steel
- Length: 16 cm

Article description	REF
Fit Rubberdam Punch	355 321



## Fit® Rubberdam-Latex

Made of natural latex rubber

- Medium: extra smooth-running due to approximal contact
- Heavy: for a stronger retention of the gingiva
- High tensile strength due to constant quality
- Durability one year minimum, if stored in a cool place
- Green sheets (15 x 15 cm), powdered on one side

Article description	Thickness	Content	REF
Fit Rubberdam-Latex, medium	0.18–0.23 mm	36 sheet	355 335
Fit Rubberdam-Latex, heavy	0.23–0.29 mm	36 sheet	355 336

For an easier and quicker insertion of the Fit Rubberdam-Latex in case of close contact points we recommend using our **Miradont-Gel** (page 33) as lubricant.

## Fit® Rubberdam Eliot Separator

Specifically for widening of interdental spaces for a short time

Article description	REF
Fit Rubberdam Eliot Separator	355 325



## Fit® Rubberdam Steel Frame

Solid stainless steel frame

- For tightening of rubber dam without perforation
- Autoclavable

Article description	REF
Fit Rubberdam Steel Frame I = large	355 324
Fit Rubberdam Steel Frame II = small	355 323

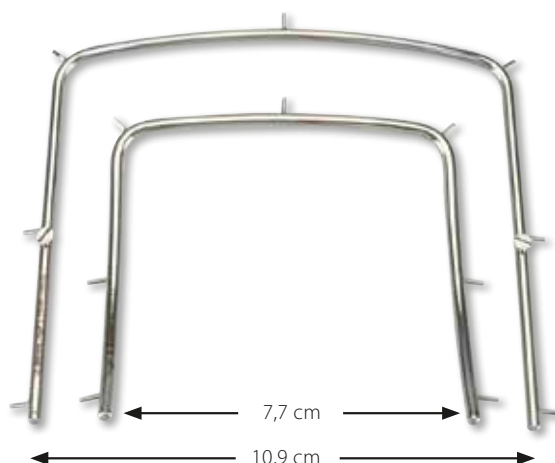

## Fit® Rubberdam Folding Frame

Foldable plastic frame

- Foldable in the center, easy access
- Avoid reflections when taking X-rays, ideal for endodontics
- Autoclavable
- Weight: 16 g

Article description	REF
Fit Rubberdam Folding Frame	355 319



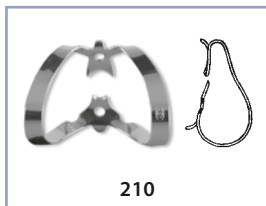

210



211

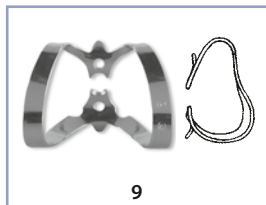

9



212

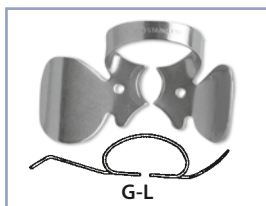

G-L

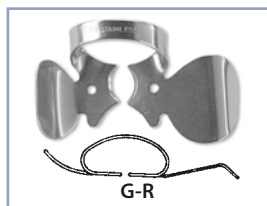

G-R

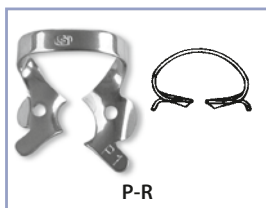

P-R

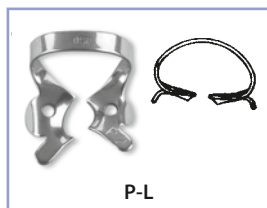

P-L



8A



138



211



1AT

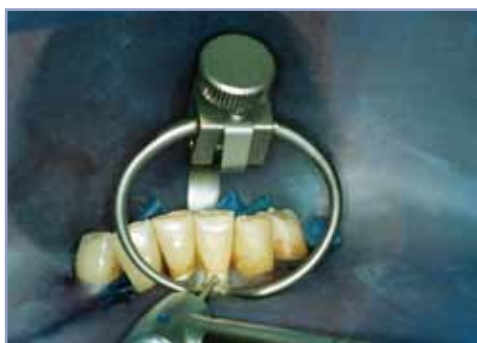

Our Fit Rubberdam clamps are made of stainless steel and every single one is adjusted accurately and effectively for the tooth it is intended for. 0.66 mm thick stainless steel is used for the high quality.

## Fit® Rubberdam Clamps

### Ivory-style (labial)

Article description	REF
210	355 384
211	355 385
9	355 355
90N (not shown)	355 371

### Ivory-style (cervical)

Article description	REF
212	355 386

### With cotton roll holder

Article description	REF
Set with clamps G-L and G-R	355 389

### For children R + L

- For the first permanent molars

Article description	REF
P-R	355 387
P-L	355 388

## Fit® Rubberdam Clamps Black

### None-reflecting black rubberdam clamps

- Dull surface blocks irritating light reflexes
- Glare-free when working with loops or intraoral cameras
- High quality stainless steel

Article description	REF	Article description	REF
0	355 770	201	355 779
2	355 771	202	355 780
2A	355 772	206	355 781
5	355 773	207	355 782
7	355 774	210	355 783
8A	355 775	211	355 784
56	355 776	1AT	355 785
138	355 777	14T	355 786
139	355 778		

## Fit® Rubberdam Cervical Clamp 214

### Special clamp

- For exposure of the tooth neck and for temporary retraction of the gingiva
- Screw fixation guarantees a firm grip
- Ideal e.g. for adhesive fixing of veneers

Article description	REF
Cervical Clamp 214	355 400



## Fit® Rubberdam T-Clamps

### Specified rubber dam T (Tiger)-clamps

- For the labial, premolar and molar area
- With special retentions for a better fixing at the tooth

#### Labial T-clamp

Article description	REF
9T	355 754

#### Premolar T-clamps

Article description	REF
1T	355 752
1AT	355 753
2T	355 750
2AT	355 751

Free 30-page Rubberdam study booklet (REF 160 001) available upon request!



#### Molar T-clamps

Article description	REF
14T	355 758
56T	355 759



## Fit® Rubberdam Clamps for Children

### Special Rubberdam clamps for children

- Especially designed for the anatomic shape of deciduous teeth
- Ideal for pediatric dentistry

Article description	Quadrant	REF
55E	upper right	355 723
54D	upper right	355 722
64D	upper left	355 724
65E	upper left	355 725
85E	lower right	355 729
84D	lower right	355 728
74D	lower left	355 726
75E	lower left	355 727
Kit with 8 clamps on a clamp board		355 720
Clamp board separately, without clamps		355 721

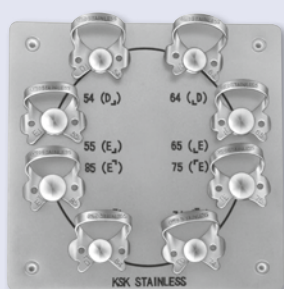

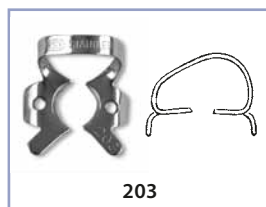
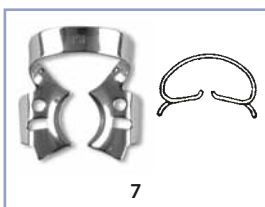
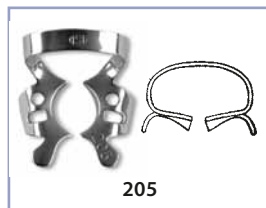
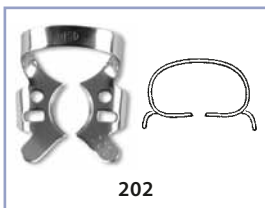
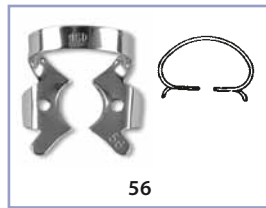
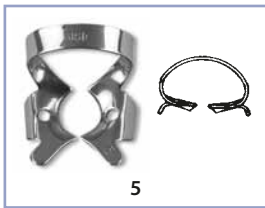
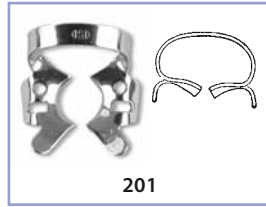
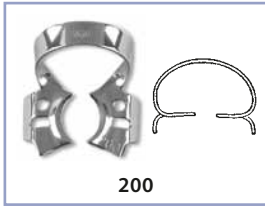
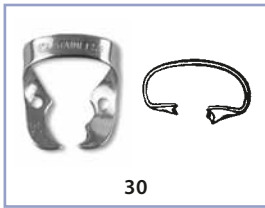
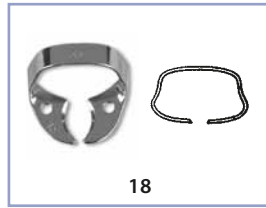
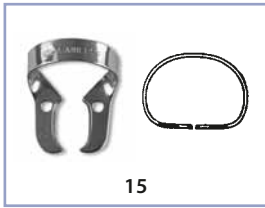

## Fit® Rubberdam Clamps

### Molar clamps wingless

Article description	REF
15	355 358
18	355 359
24	355 361
25	355 362
26	355 363
28	355 365
30	355 367
31	355 368
51	355 369
138	355 372
139	355 373
W8A	355 354

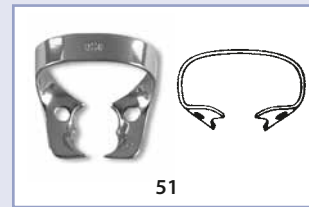

### Molar clamps with wings

Article description	REF
200	355 374
201	355 375
5	355 349
56	355 370
202	355 376
205	355 379
7	355 350
203	355 377
204	355 378
7A	355 351

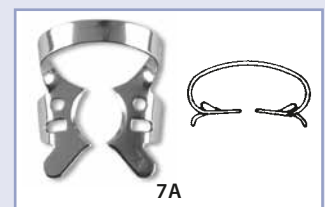
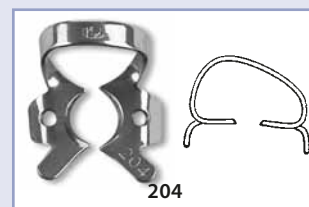

## Fit® Rubberdam Clamps

Molar clamps with wings (for deep gripping)

Article description	REF
3	355 346
4	355 348
8	355 352
8A	355 353
14	355 356
14A	355 357

Should the friction of the clamp be insufficient, an activation, e. g. with pointed forceps, is possible.

## Premolar clamps wingless

Article description	REF
W2A	355 345
22	355 360
27	355 364
29	355 366

Our Fit Rubberdam clamps are made of stainless steel and every single one is adjusted accurately and effectively for the tooth it is intended for. 0.66 mm thick stainless steel is used for the high quality.

## Premolar clamps with wings

Article description	REF
00	355 341
0	355 340
206	355 380
207	355 381
209	355 383
208	355 382
2	355 343
2A	355 344

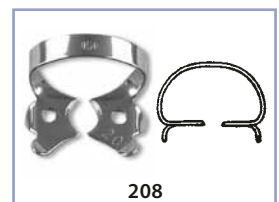
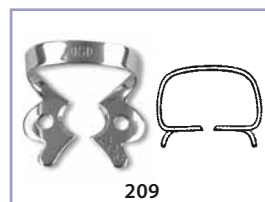
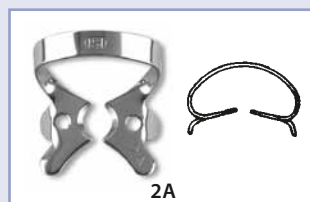
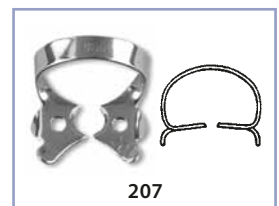
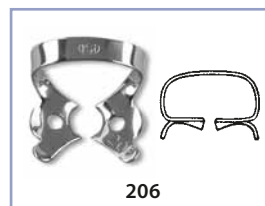



## Perfect Splint C

### Pre-curved splinting nets in four sizes

- For splinting, stabilization and interim provision
- Time-saving: easy-to-adapt and fix by bow shape
- The size of the dental arch to be treated can be determined fast and safely by the curved archetypes (C1 - C4), 98% fitting-accuracy



Measuring the dental arch on the gypsum model with a dummy.



Bridge framework. View from palatal

Article description	Content	REF
Combi set stainless steel/plastic (PET)	8 pcs. each	153 000
Set stainless steel	8 pcs.	153 001
Set plastic (PET)	8 pcs.	153 002

Refill packs with 10 bows and dummies available on request.

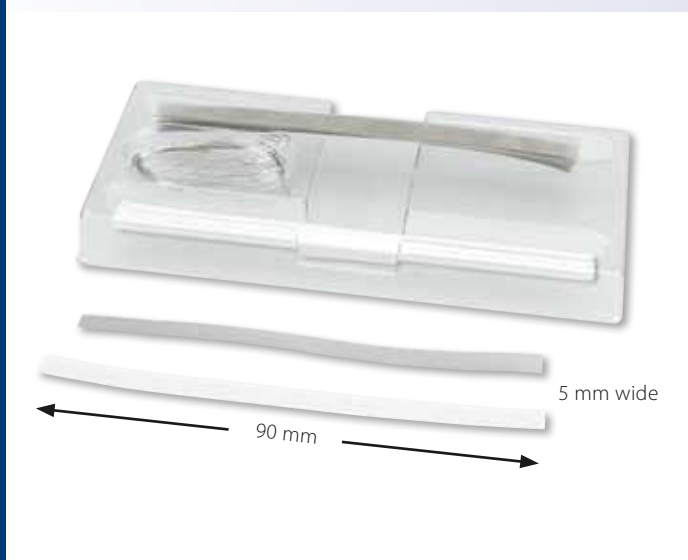

## Perfect Splint-System

### Straight splinting nets

- Cuttable plastic (PET) or stainless steel nets for splinting
- Each pack sufficient for the splinting of approx. 200 teeth

#### Complete pack

Article description	REF
10 stainless steel and plastic (PET) nets each, attachment aid (orthodontic wire)	152 280

#### Single pack

Article description	REF
20 stainless steel nets, attachment aid (orthodontic wire)	152 281
20 PET nets, attachment aid (orthodontic wire)	152 282



6 sewed on layers



4 mm wide



## Super-Splint De Luxe

### Multilayer splinter material

- 6 sewed on layers of fine meshed, ultra-thin and silanized glass fiber tape
- 4 mm wide, for approx. 25 applications

## Super-Splint

### Glass fiber tape for splinting and strengthening

- Extremely flexible, easy-to-adapt, very easy to handle and apply
- Several layers of the tape may be arranged on top of each other with composite
- 4 mm wide, silanized tape, for up to 50 applications

Article description	REF
Super-Splint De Luxe, 50 cm tape	355 848
Super-Splint, 3 m tape	355 849



## Micro-Etch

### 37% phosphoric acid

- Viscous gel
- Dyed blue for better visualization on the enamel
- Easily measured from the syringe
- For approx. 30 applications

Article description	REF
2 ml syringe with 3 canulas	152 284

Further application needles: Miraject Endo Luer (see page 13)



## Calci-Line®

### Ready for use calcium hydroxide paste (45 %)

- For direct capping after opening of the pulp or in case of pulptomy, indirect capping in case of caries profunda
- For temporary root canal fillings and root canal disinfections
- High pH-value (over 11.5) for antimicrobial effect, radiopaque
- Economic and easy-to-measure
- Appropriate underneath all underfilling and filling materials
- Incl. curing-aid cap

Article description	REF
2 ml syringe with 2 canulas	152 283

Further application needles: Miraject Endo Luer (see page 13)

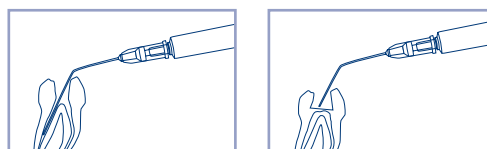

## Cyano Fast / Cyano Retarder

### Acrylic adhesive for extra-oral work

- **Fast:** normally curing bonding, adhesion and mixing fluid
- **Retarder:** slowly curing bonding, adhesion and mixing fluid

Article description	Content	REF
Cyano Fast	4 bottles with 5 g each	152 261
Cyano Retarder	4 bottles with 5 g each	152 262



## Cyano Pipettes

### Dispersations pipettes

Article description	Content	REF
Cyano pipettes	100 pcs.	152 268



## Crown Click® De Luxe

### Mechanical crown and bridge remover

- Very effective due to impulse wave
- Just place the instrument tip underneath the crown rim and release the "click"
- Instrument tip in three designs with additional loop (optional)
- Fast, efficient and easy crown and bridge removal
- High-quality, mattfinished stainless steel
- Autoclavable

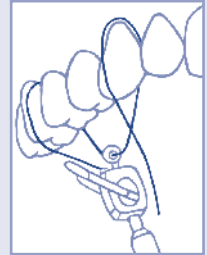

Article description	REF
Set: instrument with tips (Nr. 1 – 3)	452 205
Tip No. 1 (long)	452 206
Tip No. 2 (short)	452 207
Tip No. 3 (short+angle)	452 208
Loop tip No. 4 (incl. adapter)	452 209
Loop tip replacement wire, 2 pcs.	452 210



## B-EX® / C-EX®

### Gripping clamp for removal of bridges and crowns

- High-quality chromium-nickel alloy
- No tilting possible
- B-EX with pointed tip for bridges
- C-EX with broad tip for crowns
- Autoclavable



Article description	REF
Bridge remover B-EX	355 203
Crown remover C-Ex	355 204



## Gripit®

### Bite cushion with high adhesion force

- For removal of temporary work
- Heat bite cushion, put in place and remove temporary work by instructing the patient to open their mouth jerkily
- Safe and very convenient for the patient
- Two pieces hygienically packed

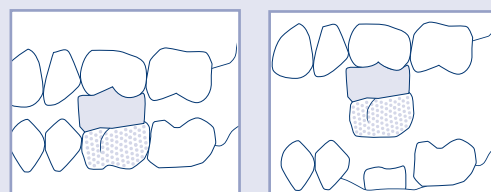

Article description	Content	REF
Gripit	50 (25 x 2) pcs.	605 283

## Occlu® Spray Plus

### High-quality green occlusion spray

- To mark contact points by spraying directly onto the occlusal surfaces
- Micro powder layer for highest accuracy
- Plastic nozzle for extra fine spray mist
- Powder layer can easily be removed with water
- Economic in consumption

Article description	Content	REF
Aerosol can green	75 ml	554 205
Aerosol can green	50 ml	554 211



## Contact Gauge

### For checking interdental contact points

- Holder made of stainless steel
- Strong stainless steel contact tapes
- In three color-coded thicknesses

Article description	Content	REF
Set with holder and 1 tape each		355 306
Replacement band separately, blue	ø 0.05 mm	355 307
Replacement band separately, red	ø 0.11 mm	355 308
Replacement band separately, yellow	ø 0.15 mm	355 309



## Artiholder

### Miller Forceps

- Artiholder in straight form
- Ideal for posterior teeth
- Stainless steel

Article description	REF
Artiholder	355 300



## Amalgam Well

### Amalgam depot made of stainless steel

- Funnel-shaped for easy pick-up
- Allows pick-up of amalgam for without skin contact
- Stable and non-slip (123 g), autoclavable

Article description	REF
Amalgam well	355 000
Del-Ject, plastic amalgam carrier, 90° angle	355 036



Del-Ject

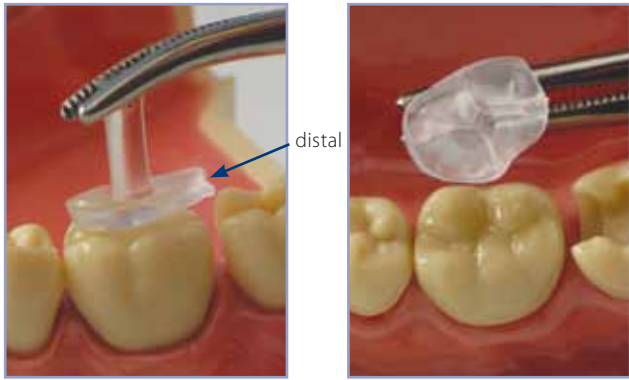

## Occlu®-Print

### Fissure stamp for composite fillings

- Easy, good and fast occlusal modulation of lateral composite fillings
- No more manual modulation of the occlusal surfaces
- Translucent plastic, may be disinfected
- Polymerization by placing the lamp onto the stamp
- Molar and premolar disposable stamp in 16 different sizes and shapes, separated into upper/lower jaw and right/left jaw
- Each stamp with related FDI-reference number

Article description	REF
Intro kit with 32 stamps (16 x 2 pcs.)	605 494

Refills with 10 pcs. each, available separately in 16 sizes on request.



## Mirafit Core

### Fiber-reinforced core build-up material

- Dual-hardening hybrid composite with specially treated glass fiber
- Contains fluoride and is radiopaque
- Grindability similar to dentin
- High pressure resistance, also underneath full ceramic or composite restorations
- For cementation of posts or as restoration material for prepared teeth
- Easy application, as the material is directly mixed in a mixing canula
- Additional light polymerization guarantees complete curing
- Available in 4 colors: A2, A3, blue, opaque white



#### Assorted Set:

5 syringes with 4 ml / 8.6 g per color, incl. 25 mixing tips and 25 oral tips

#### Refill Set:

2 syringes with 4 ml / 8.6 g per color, incl. 25 mixing tips and 25 oral tips

Article description	Farbe	REF
Mirafit Core, Set		152 230
Mirafit Core, Refill	A2	152 241
Mirafit Core, Refill	A3	152 242
Mirafit Core, Refill	blue	152 244
Mirafit Core, Refill	Opalescence white	152 245

## Mirafit® BC

### Plastic caps for core build-up

- Time-saving as modelling of the cured core is simplified
- Cost- and material saving
- Minimized risk of accidental damage to neighboring teeth
- Standard shape of caps suits any core build-up
- Transparent and light conducting caps in six sizes
- Thin-walled caps can simply be adapted with scissors
- May basically be used with any commercial root canal post system and core build-up composite

Article description	REF
Kit of 72 with 12 caps each in 6 sizes	605 470

Refill kits with 10 caps per size on request

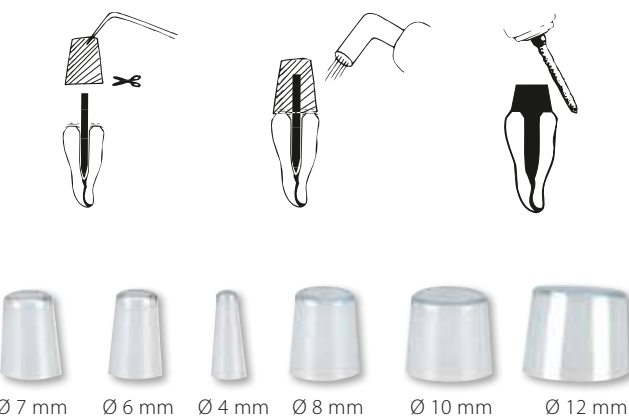



## Mirafit® 3in1

### Build-up post made of white glass fiber

- Biocompatible material, physical properties similar to dentine
- Thread-free, gentle to the tooth substance, radiopaque
- Cone-shaped, size may be adjusted individually with the aid of three color marks on the post:
- Yellow mark: Post length 2.9 mm, approx. ISO size 60
- Red mark: Post length 8.25 mm, approx. ISO size 80
- Blue mark: Post length 17.5 mm, approx. ISO size 110 (overall post length 35 mm)

Article description	REF
Kit: 6 posts, 1 depth reamer and 3 root canal reamers	356 074

#### Refill packs

Article description	Content	REF
Posts	6 pcs.	356 080
Depth reamer	3 pcs.	356 081
Root canal reamer yellow, small	3 pcs.	356 082
Root canal reamer red, medium	3 pcs.	356 083
Root canal reamer blue, large	3 pcs.	356 084

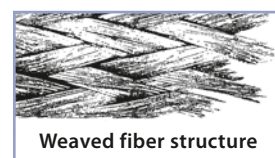
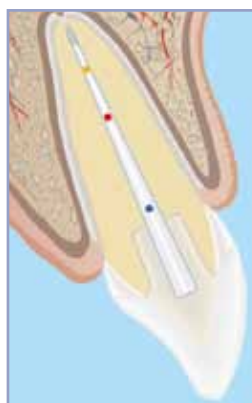

## Mirafit® Carbon and White

### Thread-free reconstruction posts made of carbon and glass fiber

- Physical properties of the post similar to those of dentine and reconstruction composite
- No risk of corrosion due to biocompatible metal-free material
- Preparation very gentle to the tooth substance
- Extra-long and easy to shorten post, can easily be removed by means of a bur
- Available in 3 conventional diameters:
- L2 = Ø 1.20 mm    L3 = Ø 1.35 mm    L4 = Ø 1.50 mm

#### Mirafit Carbon

- Post visible on X-rays due to radiopaque cement

#### Mirafit White

- The white color of the post meets high esthetical requirements
- Radiopaque

Article description	Content	REF
Mirafit Carbon kit	3 x 6 posts and 1 reamer each	356 040
Mirafit Carbon, post L2	Ø 1.20 mm, 6 pcs.	356 041
Mirafit Carbon, post L3	Ø 1.35 mm, 6 pcs.	356 042
Mirafit Carbon, post L4	Ø 1.50 mm, 6 pcs.	356 043
Mirafit White kit	3 x 6 posts and 1 reamer eac	356 044
Mirafit White, post L2	Ø 1.20 mm, 6 pcs	356 045
Mirafit White, post L3	Ø 1.35 mm, 6 pcs.	356 046
Mirafit White, post L4	Ø 1.50 mm, 6 pcs.	356 047
Mirafit reamer L2	3 pcs.	356 048
Mirafit reamer L3	3 pcs.	356 049
Mirafit reamer L4	3 pcs.	356 050

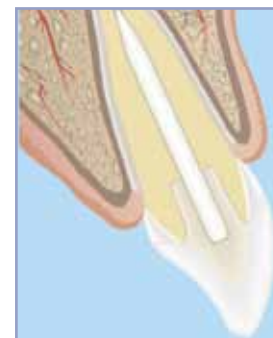

Gold-plated

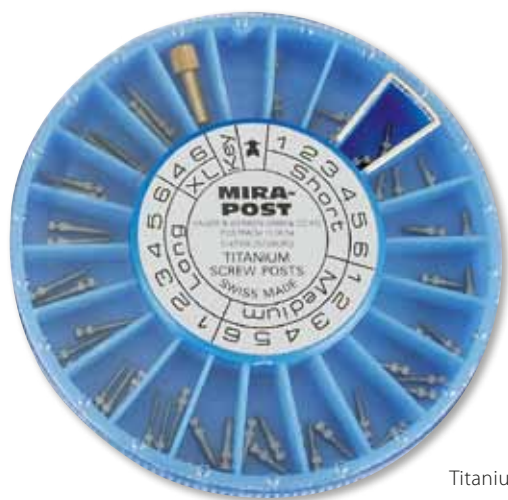









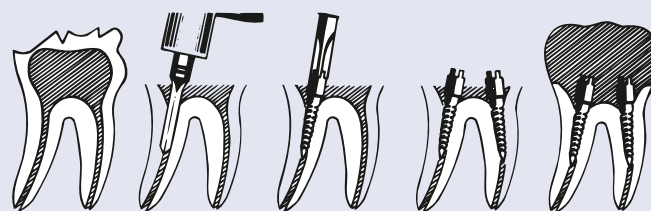





















Titanium

## Mirapost®

### Inexpensive build-up post

- Self-cutting thread
- In two versions: titanium and 24 carat gold-plated
- Gets directly screwed in or cemented
- In four lengths: short (8 mm), medium (9.5 mm), long (12 mm), x-long (14 mm)
- In six diameters: No. 1 (1.05 mm), No. 2 (1.20 mm), No. 3 (1.35 mm), No. 4 (1.50 mm), No. 5 (1.65 mm), No. 6 (1.80 mm)
- Sets include three, six or twelve posts per size



	S (8 mm)	M (9.5 mm)	L (12 mm)	XL (14 mm)
<b>Reamer NF (Pack of 3)</b>				
				
<b>No. 6</b> (ø 1.80) 356 025	G 355 981 Ti 356 004	G 355 987 Ti 356 010	G 355 993 Ti 356 016	G 355 995 Ti 356 018
				
<b>No. 5</b> (ø 1.65) 356 024	G 355 980 Ti 356 003	G 355 986 Ti 356 009	G 355 992 Ti 356 015	
				
<b>No. 4</b> (ø 1.50) 356 023	G 355 979 Ti 356 002	G 355 985 Ti 356 008	G 355 991 Ti 356 014	G 355 994 Ti 356 017
				
<b>No. 3</b> (ø 1.35) 356 022	G 355 978 Ti 356 001	G 355 984 Ti 356 007	G 355 990 Ti 356 013	
				
<b>No. 2</b> (ø 1.20) 356 021	G 355 977 Ti 356 000	G 355 983 Ti 356 006	G 355 989 Ti 356 012	
				
<b>No. 1</b> (ø 1.05) 356 020	G 355 976 Ti 355 999	G 355 982 Ti 356 005	G 355 988 Ti 356 011	

Refill packs available on request:  
6 titanium reamers or 12 gold-plated reamers.

### Gold-plated set with hollow and cross-type driver, titanium set with hollow driver

Article description	Content	REF
Set 240, gold-plated	20 x 12 pcs.	355 975
Set 120, titanium	20 x 6 pcs.	355 998
Set 60, gold-plated	20 x 3 pcs.	355 974
Set 60, titanium	20 x 3 pcs.	355 973

### Reamer

Article description	ø	Content	REF
Set 1-6		6 pcs.	355 997
No. 1	1.05	3 pcs.	356 020
No. 2	1.20	3 pcs.	356 021
No. 3	1.35	3 pcs.	356 022
No. 4	1.50	3 pcs.	356 023
No. 5	1.65	3 pcs.	356 024
No. 6	1.80	3 pcs.	356 025
Hollow driver, separately			356 027
Cross-type driver, separately			356 028

## Endo N2®

### Root canal cement on zinc oxide – eugenol basis

- Inexpensive and fast alternative for more than 50 years
- Can be used separately or as a sealer in connection with Gutta Percha points
- Easily to be rotated into the canal
- Good adhesion to canal walls
- Definite, not absorbable filling with a chalk-like hardness after curing
- Antimicrobial effect gradually decreasing with curing
- Consisting of powder and liquid for mixing

Article description	Content	REF
Set	10 g powder, 6 g liquid	152 027
Powder separately	10 g	152 028
Liquid separately	6 g	152 029

"In more than 8,800 EDP-registered vital extirpations in the period from 1985 – 1999 the treatment needed more than one session to be finished in only 22 cases (5 own, 17 assistant). I have not counted thousands of vital amputations and milk tooth endos."  
Dr. Robert Teeuwen



X-ray control

## Desmoclean®

### Instruments for gentle root planning

- For curettage of the root surface in deep pockets, for bi- and/or tri-furcation and in the approximal area
- For removal of tightly adhesive granulations
- For removal of concrement (subgingival plaque)
- For periost ablation during flap surgery
- Non-cutting hexagonal head – as gentle as a manually operated device and as fast as diamonds
- At least 30 – 50 periodontias can be treated per instrument
- To be used with 7,000 – 10,000 rpm with light pressure and water spray

Article description	REF
Intro kit with 6 pieces per shape (24 pieces)	503 290
Minikit with 1 piece per shape (4 pieces)	503 263

#### Single shapes

Article description	Content	REF
I	12 pcs.	503 291
II	12 pcs.	503 292
III	12 pcs.	503 293
IV	12 pcs.	503 294



Desmoclean original size (two shaft lengths and two head sizes)

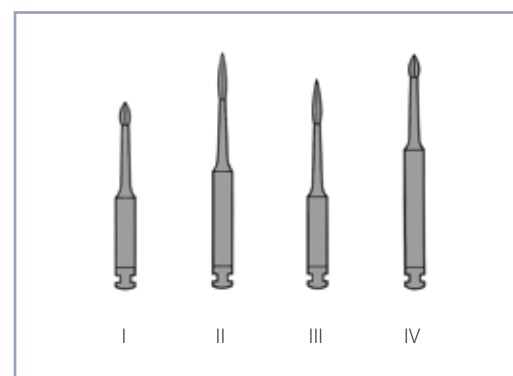



## Miraclean-Implant Black

### Cleaning instruments for implants

- Black colored instruments for great contrast
- Double-ended, in 4 special shapes
- Autoclavable and chemiclavable plastic material

Article description	REF
Set of 4 instruments	355 220
Instrument separately: No. 1, Side tooth	355 221
Instrument separately: No. 2, Luniatschek + scaler	355 222
Instrument separately: No. 3, Anterior tooth	355 223
Instrument separately: No. 4, Abutment	355 224



## Fit-N-Swipe

### Adhesive, single-use cleaning pad

- For clean instruments and mouth mirrors
- High cleaning effect and highly absorbent
- Practical, single-handed use
- Sterilisable\* and hygienic

Article description	Content	REF
Fit-N-Swipe Clean, white	50 pcs.	605 251
Fit-N-Swipe Clean, blue	50 pcs.	605 252



\* Sterilize in autoclave before use! For single use!



## Miraglu®

### Tissue adhesive for sealing of skin and mucosa injuries

- Excellent adhesive characteristics on humid tissue
- Cyano acrylate liquid in monomer form, polymerizes when getting into contact with water/body fluid
- Thin, absolutely dense film fixes wound borders tightly due to short setting time
- Immediate pain relief because of wound-sealing
- Wounds heal fast and without complications
- No scarring, no need to remove stitches
- Suitable to cover up minor cuts

Article description	REF
Tube with 3 g, 20 fine dosing pipettes and 2 mixing dishes	155 015



Before treatment



After treatment with Miraglu



## Reso-Pac®

### Adhesive periodontal dressing based on cellulose

- To be applied directly to wounds, sutures and pressure spots
- Keeps out bacteria and assists the healing process
- Remains for up to 30 hours and is self-dissolving
- Ideal for protection of wounds and sutures in implantology, periodontics, following extractions, in orthodontics and prosthodontics
- Ideal as a medicament carrier
- Patient-friendly as it stays soft, is odorless and neutral in taste



Article description	Content	REF
Reso-Pac	25 g	155 011
Reso-Pac value pack	5 x 25 g	155 010
Reso-Pac single portions	50 x 2 g	155 014



2 g

## Miradont®-Gel

### Micronutrient gel for intensive oral care

- Accompanying therapy in aphthae and oral lesions
- Regenerating and revitalizing
- For irritated and stressed oral mucosa
- No added alcohol, saccharin, menthol, and preservatives

Article description	Content	REF
Miradont-Gel	15 ml	155 000





## Spandex®

### Cheek and lip retractor

- Allows for a free view and working field
- Ideal for treatment of anterior teeth
- Made of non-reflecting plastic
- Autoclavable



Article description	Content	REF
Regular	2 pcs.	605 454
Mini (children)	2 pcs.	605 455



## Spandex®-Vertical

### Lip retractor

- Expands patients mouth in vertical direction
- For treatment at the gingival border of anterior teeth
- Autoclavable

Article description	Content	REF
Spandex-Vertical (2 x medium, 2 x small)	4 pcs.	605 211



## Mirahold®

### One sided cheek retractor

- With long handle for a free working field
- Useful, e.g. for injections
- Convenient for the patient
- Autoclavable



Article description	Content	REF
Mirahold regular	2 pcs.	605 450
Mirahold bambino	2 pcs.	605 451

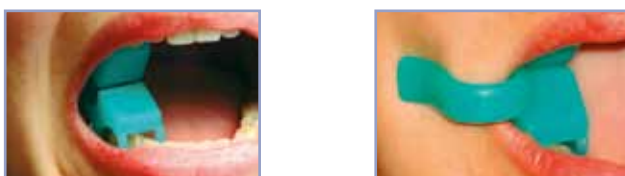

## Mirahold®-Block

### Elastic bite blocks for mouth opening

- Plastic block to keep the mouth open reliably
- The set includes a special cheek retractor
- Ideal for longer treatments and anxious patients
- Autoclavable

Article description	REF
Set with 12 bite blocks, 6 small and large each and 2 cheek retractors	605 210
Intro set with 6 bite blocks, 3 small and large each and 1 cheek retractor	605 238
Mini set with 3 bite blocks (small)	605 220
Cheek retractor separately	605 239

## Variator®-Kit

### Disposable treatment set

- Comprises mouth mirror, tweezers and probe
- Big spatula for mixing of cement and filling materials
- Ball head and Heidemann spatula for stuffing
- Practical for home visits, high-risk patients and in emergencies
- All three instruments are sterile and blister-packed as a unit

Article description	Content	REF
Variator-Kit, set with 3 instruments	10 sets	355 441



## Liftbox

### Disinfection box for dental instruments

- By closing the cover, the filled tray submerges into the disinfectant
- Tray with swivel handle for easy handling
- No direct skin contact with aggressive disinfectants
- Acid-resistant plastic
- Dimensions: (WxHxD): ca. 26 x 8.5 x 12cm
- Container content: ca. 1.5 l

Article description	REF
Liftbox	355 140



## Miralay

### High-quality inlay adapter

- Instrument with single rubber inserts and counter metal pin
- Autoclavable

Article description	Content	REF
Miralay set, 2 instruments + 4 bite blocks		355 210
Miralay replacement rubber inserts (cover)	2 pcs.	355 213



Illustration similar

## Matrix-Spanner

### Matrix retainer "Tofflemire" style

- High-quality stainless steel
- Autoclavable



Article description	REF
Standard universal No. 1	355 043
Angled No. 2	355 047
Junior (short) No. 3	355 048



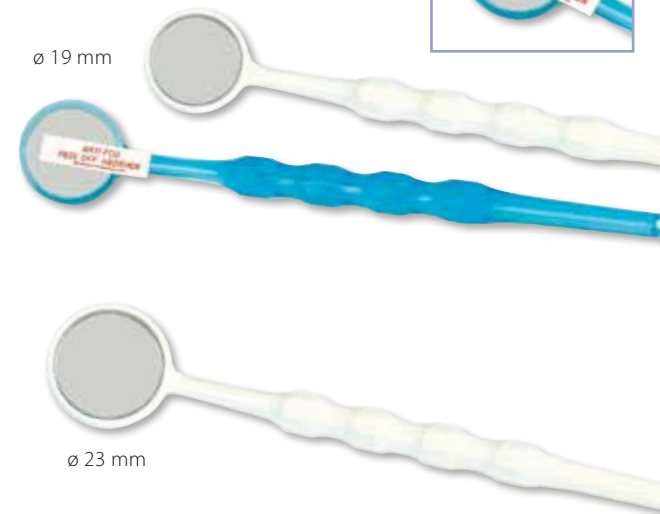

## Brilliant Anti-Fog

### Disposable anti-fog mouth mirror made of plastic

- With anti-fog coating
- Flat, angled mirror head for access to all areas in the oral cavity
- Ergonomic finger-grip handle
- Each mirror protected with peel off foil and single packed

Article description	Content	REF
White, ø 19 mm	50 pcs.	605 416
Transparent blue, ø 19 mm	50 pcs.	605 417

## Brilliant

### Disposable mouth mirror made of plastic

- Without anti-fog coating
- Available in two sizes, ø 19 mm and ø 23 mm
- Each mirror protected with foil and single packed, 100 pieces

Article description	Content	REF
No. 4, white, ø 19 mm	100 pcs.	605 400
No. 5, white, ø 23 mm	100 pcs.	605 399

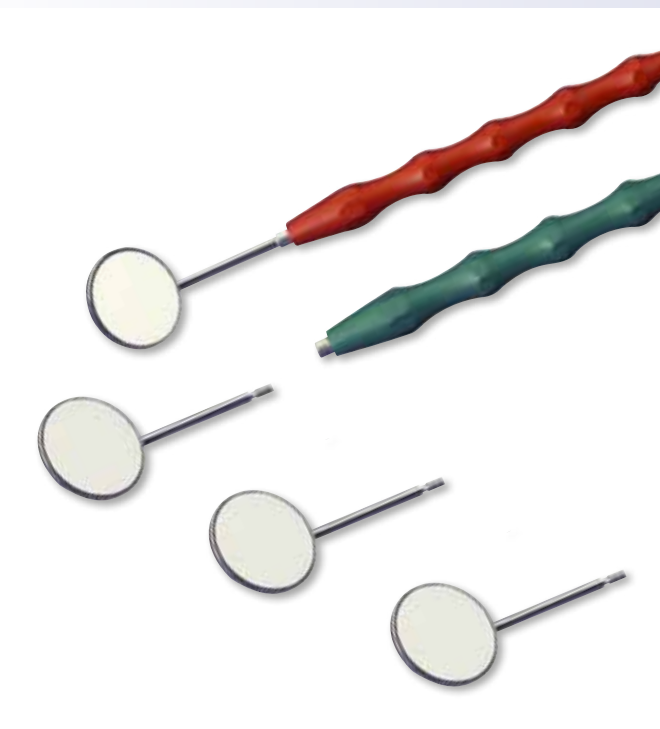

## Mouth Mirror Finger-Grip Handle

### Plastic mirror handles

- Autoclavable high-quality plastic
- Non-conducting (e. g. for electro surgery)
- Ergonomic shape, lightweight, 10 g only
- For mirror heads see following product Durotanic

Article description	Content	REF
Mouth Mirror Finger-Grip Handle, red	3 pcs.	355 554
Mouth Mirror Finger-Grip Handle, green	3 pcs.	355 551

## Durotanic® Mouth Mirror

### Rhodium-coated front mirror

- Rust-proof high quality
- Durable, distortion-free, sterilizable
- Small "slimline" head

Article description	Content	REF
Durotanic Mouth Mirror size 4	12 pcs.	355 453
Durotanic Mouth Mirror size 5	12 pcs.	355 454



## Mirodent

### Plastic, disposable mouth mirror

- No misting due to „anti-fog coating“
- Mirror can be removed from the handle and be replaced by a new mirror, reduces waste

Article description	REF
Mirodent, 100 mirrors + 4 handles (one-ended)	605 404
Mirodent, one-ended handle	605 405



## Reflect-Rhod

### Rhodium-coated metal mouth mirror

- Ideal for distortion-free intra-oral photos
- Extensive rhodium coating on one side
- Sturdy, durable
- With detachable silicone handle
- Autoclavable in the provided fabric bag

Article description		REF
Set with 3 mirrors		355 480
No. 1, separately	(40 x 163 mm)	355 481
No. 2, separately	(69 x 163 mm)	355 482
No. 3, separately	(79 x 163 mm)	355 483
Silicone handle separately	(40 x 52 mm)	355 487

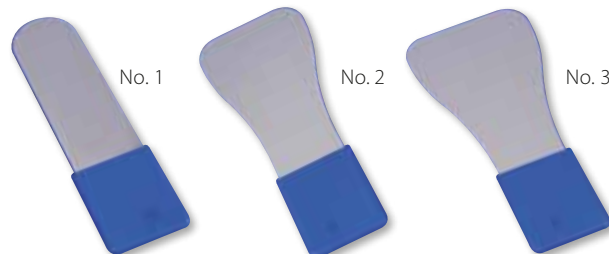
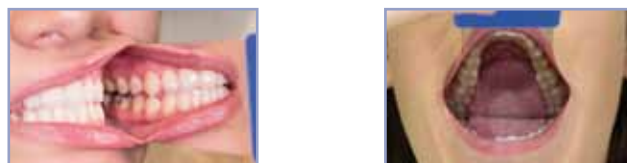

## Parallelometer-Mirror

### Mirror with parallel lines

- A proven specialty according to Prof. Böttger
- Fits all popular mirror handles (excluded from scope of delivery)
- Parallel check before imprint
- Autoclavable

Article description	REF
Parallelometer-Mirror	355 470



## Cold-Bag

### Cold compress for pain relief

- Instantly applicable, cools for approx. 30 minutes at ca. 5 - 10 °C
- Develops effective iciness within seconds
- Reduces swellings

Article description	Content	REF
Cold-Bag compresses	10 pcs.	605 501



## Miracold® Plus

### Cooling spray

- Approx. -50°C at the application canula (plastic)
- Orange flavor
- For vitality testing of devital teeth

Article description	Content	REF
Miracold Plus	200 ml	554 213



## Orange Solvent®

### Cleansing solution

- For the removal of impression pastes, zinc oxide cements, dispersion adhesive (stickers, labels) from instruments
- Ideal for cleaning stainless steel
- Surfaces become shiny and are protected
- Fresh orange scent
- Available as liquid and spray

Article description	Content	REF
Orange Solvent liquid	250 ml	554 102
Orange Solvent spray	200 ml	554 201







## Praxipolish® Plus

### Cleansing foam for dental practices

- Removes dirt, dirt rims, stains, etc. without effort
- For devices, plastic and wooden surfaces, etc.
- With ultra-hygienic features
- Tested by the neutral German "Institute for Hospital Hygiene and Infection Control" (IKI Gießen)

Article description	Content	REF
Praxipolish Plus	400 ml	554 208



## Astro Clean®

### Spray disinfection

- Particularly for disinfection of (Hager iSpec) protective glasses (page 67)
- No damage to the anti-fog coating
- Generally usable for all surfaces in the medical field
- Bactericidal, fungicidal and virus-inactivating (HBV and HIV)

Article description	Content	REF
Astro Clean	250 ml	554 301

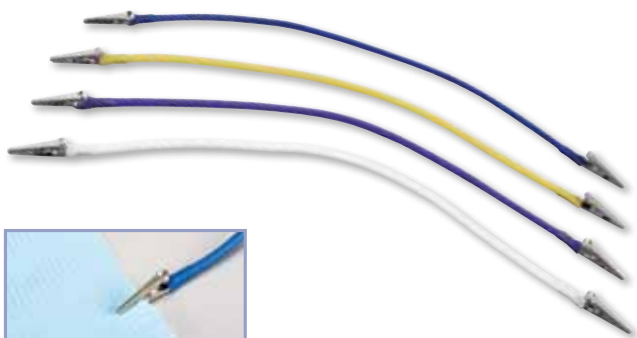

Total length 42 cm

## Miraclip

### Napkin holders

- Made of autoclavable rubber material with stainless steel clips

Article description	REF
Miraclip, blue	605 240
Miraclip, yellow	605 241
Miraclip, violet	605 242
Miraclip, white	605 243
Set of 4, 1 of each color	605 228
Set of 8, 2 of each color	605 229



## Hager iSpec® spectacle wipes

- Suitable for plastic and glass spectacles
- The anti-fog and anti-scratch coatings remain unimpaired
- Thorough and streak-free cleaning
- Also suitable for face shields
- Individually wrapped and silicone free

Artículo	Content	REF
Spectacle wipes	100 pcs.	355 657

## Flexbrush

### Autoclavable nail brush

- Excellent for the cleaning of hands before and after treatment
- Extra long, hard-wearing bristles on the bottom
- Short bristles on the top
- Autoclavable – meeting hygiene requirements

Article description	REF
Flexbrush	605 254



## Fit-N-Fix

### Disposable, hygienic napkin holder

- Easy to use: Remove protective foil and stick to paper napkin
- Stretch material made of soft silk like fiber for patient comfort
- Works with all bibs
- Easy handling and hygienic disposal
- Two flowery colors



Article description	Content	REF
Fit-N-Fix, blue	200 pcs.	605 249
Fit-N-Fix, pink	200 pcs.	605 250



## Miramask®

### Disposable mask made of lightweight fleece material

- Hygienic and very good value for money

Article description	Content	REF
Miramask	100 pcs.	605 412



## Cotton-Clip

### Cotton roll holder

- Holds cotton rolls securely in place for a dry working field
- Available in light plastic or solid, autoclavable stainless steel

Article description	Content	REF
Cotton-Clip I, plastic	100 pcs.	605 350
Cotton-Clip II, stainless steel	8 pcs.	605 351



## Cottoroll

### Cotton roll dispenser

- Hygienic, dry storage
- Quick and easy to access – simply open the drawer
- Drawer refills automatically
- Convenient top-loading function
- Stable, nonslip

Article description	REF
Cottoroll	355 132





## Chirurgo-Suc I

### Sterile disposable surgical aspiration canula

- Extremely long (20 cm) for a free working field
- Fits all hoses with adapter
- Transparent plastic
- Individually sterile sealed
- Canula diameter: 2 mm

**Set with 10 pieces incl. Mirasuc Adapter**

(REF 254 130 and 254 132 - see page 41)

Article description	REF
Chirurgo-Suc I	254 000

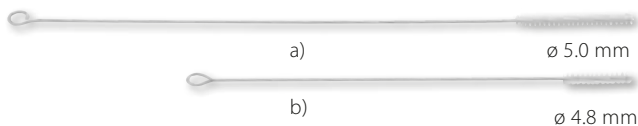

## Steri-Suc-Tube

### Surgical aspiration canula

- Made of high-quality, transparent, honey-colored plastic
- Safe when getting into contact with activated electrodes (e.g. p. 64) or rotating instruments
- Autoclavable
- Fits to saliva ejector (6 mm) without adapter
- Ultra-light, approx. 3 g weight
- Incl. one Chiru-Cleaner brush (No. 23, REF 605 215)

Article description	Content	REF
Steri-Suc-Tube	10 pcs.	254 060

## Chiru-Cleaner®

### Cleaning brushes for surgical canulas

Article description	Content	REF
a) Chiru-Cleaner 23, 23 cm long	12 pcs.	605 215
b) Chiru-Cleaner 16, 16 cm long	6 pcs.	605 217



## Mirasuc® Brush

### Cleaning brush for aspiration canulas

- Bendable, ideal for the cleaning inside of canulas
- For all aspiration canulas with ø 11 mm and 16 mm, length 18.5 cm

Article description	Content	REF
Mirasuc Brush	6 pcs.	605 216



## Skalpell-Ex / Pin-Clipper

### Special tweezers with dual function

#### Special tweezers with pin

- For holding crowns and bridges
- Locking function

#### For removal of scalpel blades

- Easy and safe removal of blade due to lever action

Article description	REF
Skalpell-Ex / Pin-Clipper	355 449

**We recommend the Miramatic-Box for the disposal of contaminated scalpels (see page 16)**

## Pelotte Plus

### Autoclavable plastic aspiration canula

- Very convenient for the patient, with round head
- Also ideal in pediatric dentistry
- ø 11 mm, length 10,5 cm
- Autoclavable

**Set with 10 pieces, including 1 adapter (from ø 11 mm to 16 mm)**

Article description	Content	REF
Pelotte Plus, green incl. 1 adapter	10 pcs.	254 024

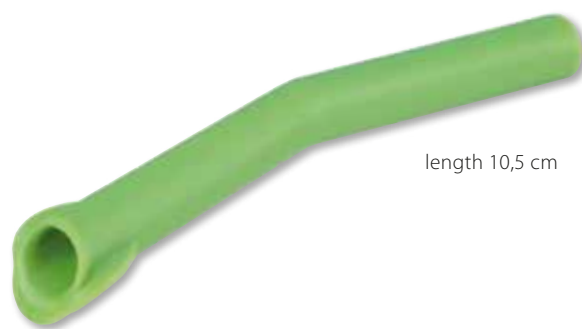

ø 11 mm

length 10,5 cm

## Pelotte-Aspirator

### Disposable plastic aspiration canula

- Canula with round head
- ø 11 mm, length 10 cm

**Box with 50 pieces, including 1 adapter (from ø 11 mm to 16 mm)**

Article description	Content	REF
Pelotte-Aspirator, white	50 pcs.	254 022
Pelotte-Aspirator, orange	50 pcs.	254 023



ø 11 mm

length 10 cm

## Mirasucto®

### Longer disposable plastic aspiration canula

- With square head
- ø 11 mm, length 14 cm

**Box with 50 pieces**

Article description	Content	REF
Mirasucto, white	50 pcs.	254 020
Mirasucto, orange	50 pcs.	254 021



ø 11 mm

length 14 cm

## Mirasuc® Adapter

### Extensions and connecting pieces for aspiration canulas

- Made of plastic, for all conventional suction units
- Extension from 6 mm to 16 mm (e) possible by combination of adapters (a) and (d)

Article description	REF
a) white, from 11 mm to 16 mm	254 130
b) orange, from 11 mm to 16 mm	254 131
c) gray, autoclavable, finger-grip handle extends the canula from 11 mm to 16 mm	254 133
d) white, from 6 mm (salvia ejector) to 11 mm	254 132
e) Combination of adapter a) and d), from 6 mm to 16 mm	

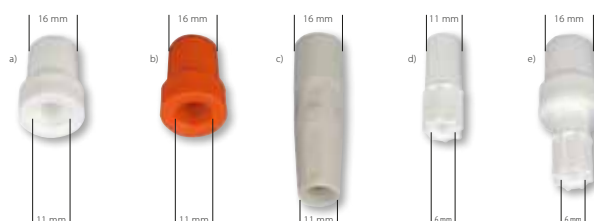



## Mira-2-Ton® Solution

### Plaque test

- Older plaque is revealed in blue, newer plaque in pink
- Proven in the dental practice for years
- Motivating quality control for dental assistant and patient
- Erythrosine- and gluten-free
- Discolorations can be removed by brushing teeth

Article description	Content	REF
Mira-2-Ton Solution	60 ml	605 655

For further Mira-2-Ton products see page 86.



## Mira-Clin P®

### Approved prophylaxis paste with coarse granulation

- For professional tooth cleaning in the dental surgery
- Low abrasion with optimal cleaning effect
- Pleasant fruit taste
- Free of fluoride and menthol

Article description	Content	REF
Mira-Clin P	250 g	605 656
Box with 200 dishes, 2 g each and stainless steel finger ring II		605 658
Finger ring II, separately		605 444



## Mira-Clin® hap

### Prophy Paste with hydroxylapatite

- For professional tooth cleaning and polishing
- Supports treatment of hypersensitive tooth necks
- Removes coatings and discoloration gently while building a protective layer on teeth and tooth necks
- Cleaning particles change size from coarse (cleaning) to fine (polishing)
- With toothfriendly Xylitol
- Pleasant mint taste
- Free from gluten and phthalate

Article description	Content	REF
Mira-Clin hap	75 ml	605 654



## Dapp-a-Way

### Disposable dappen dishes

- Set with 1,000 plastic dishes

Article description	Content	REF
Set incl. 1 finger ring	1000 pcs.	605 445
Finger ring separately		605 446

## Prophy-Ring

### Stainless steel holder for dappen dishes

- Practical metal ring for attaching to the finger
- For chairside application

Article description	REF
Prophy-Ring	605 657



## Prophy-Cup®

### Rubber cups for prophylaxis

- For single use
- Latex-free
- Available in two degrees of hardness

Article description			Content	REF
Screw on	regular	blue	50 pcs.	605 832
Screw on	soft	green	50 pcs.	605 833
Snap on	regular	blue	50 pcs.	605 830
Snap on	soft	green	50 pcs.	605 831
Contra Angle	regular	blue	50 pcs.	605 834
Contra Angle	soft	green	50 pcs.	605 835



soft regular soft regular

## Prophy-Angles

### Angled rubber cups

- For single use
- Latex-free
- In two hardnesses
- For hand pieces only

Article description		Content	REF
Regular	violet	100 pcs.	605 836
Soft	green	100 pcs.	605 837

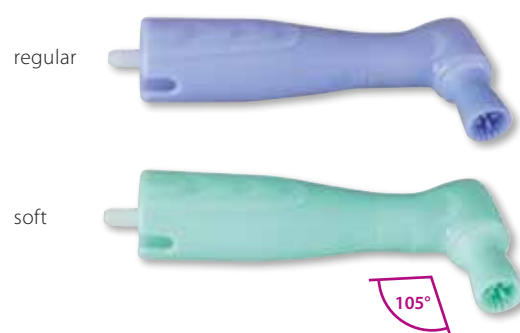

regular

soft

## Rotoprox®

### Micro spiral brush with stainless steel shaft

- For cleaning and polishing hard-to-reach areas, e.g. interdental spaces, etc.

#### Rotoprox Mini

Article description	Content	REF
Straight (20 mm long)	50 pcs.	605 792

#### Rotoprox

Article description	Content	REF
Rotoprox for CA ø 2.0 mm X-fine/straight 27 mm long	10 pcs.	605 719
Rotoprox for CA ø 2.2 – 2.5 mm Fine/conical 27 mm long	10 pcs.	605 721



Rotoprox Mini



Rotoprox

## Clean-Jet® Powder

### Special cleaning powder

- Highest cleaning effect and very low abrasion by extra fine granulation
- Pleasant lemon flavor
- Easy powder feeding by dosing bottle

Article description	Content	REF
Clean-Jet powder	400 g	605 380





## Compo Blitz

### Diamond impregnated natural felt wheel

- Buffs composites, ceramic and porcelain to a high luster finish
- Polishes in 15 sec., friction temperature <30 °C
- Mounted for C.A.
- Wheels of ø 9 mm in 2 sizes:
  - 1.5 mm / thin
  - 3 mm / thick

Article description	Content	REF
Set assorted, 6 each	12 pcs.	503 086
Thin 1.5 mm	12 pcs.	503 087
Thick 3 mm	12 pcs.	503 088



## Compo-Brush

### Application Brushes

- Ideal for etching and bonding agents, pit and fissure sealants, calcium hydroxides, Mira-2-Ton, medicaments, varnish, etc.
- Brushes available in 2 thicknesses:
  - No. 10 - fine, white
  - No. 11 - micro-fine, brown (not shown)
- Compatible with Mouth Mirror Finger-Grip Handle (see page 36)

Article description	Content	REF
Brushes No. 10 (fine)	100 pcs.	605 231
Brushes No. 11 (micro-fine)	100 pcs.	605 232
Mirodent, one-ended handle	1 piece	605 405



## Mira Clean

### Mouth rinsing tablets for dissolving

- Refreshing, slightly antiseptic, cooling
- The little extra service for the patient
- Ideal for prophylaxis treatments
- Pastilles dissolve completely within max. three minutes
- In two pleasant flavors: mint and thymol

Article description	Content	REF
Mint (green)	1,000 pastilles	605 504
Thymol (pink)	1,000 pastilles	605 505



250 ml

500 ml

## Dosing Bottle

### Transparent squeeze bottles

- With fine jet tip and delivering tube
- For fine dosing of liquids
- In two sizes

Article description	Content	REF
Dosing Bottle	250 ml	304 405
Dosing Bottle	500 ml	304 406

## BD-Steribox

### Container for disinfection

- Useful for small parts, such as burs, diamonds, etc.
- With opening in the lid
- With removable sieve for rinsing the content
- Both versions autoclavable
- Measures: Plastic: Total height approx. 12 cm,  $\varnothing$  approx. 8 cm  
Metal: Total height approx. 5 cm,  $\varnothing$  approx. 9 cm

Article description	REF
BD-Steribox plastic	355 139
BD-Steribox metal	355 138



## Clip-Clap

### Stainless steel mesh

- Ideal for ultrasonic cleaning
- To safely scald sensitive small parts
- 45 mm diameter of ball-shaped strainer

Article description	REF
Clip-Clap	304 140



## Twin-Pipette

### Pipette with two chambers

- For measuring out the exact dosage of drops or for thorough rinsing
- Front chamber = drops, rear chamber = rinsing
- Pipette end can be cut off for increased flow, e.g. for subgingival rinsing

Article description	Content	REF
Twin-Pipette	100 pcs.	605 352



## Strip Holder

### Stainless steel matrix band holder

- For fixing of matrix bands
- With special serration and spring

Article description	REF
Strip Holder	605 337





With level indicator



## Mirafluor®-Tray

### Application tray for fluoride gel

- Made of light, flexible plastic
- With level indicator
- Double tray for simultaneous treatment of maxilla and mandible
- In yellow color, contrasting any gel

Article description	Content	REF
Mirafluor-Tray, small	50 pcs.	605 620
Mirafluor-Tray, medium	50 pcs.	605 621
Mirafluor-Tray, large	50 pcs.	605 622



mirafluor-k-gel  
for children

## mirafluor®-gel / k-gel

### Fluoride gel for intensive tooth decay prophylaxis

- Increases the acid resistance of the enamel
- Decreases plaque formation
- Accelerates the remineralization
- mirafluor-gel with 1.23 % fluoride
- mirafluor-k-gel with 0.6 % fluoride is particularly suited for children aged 6 or older

Article description	Content	REF
mirafluor-gel, mint	250 ml	605 800
mirafluor-gel, strawberry	250 ml	605 801
mirafluor-k-gel, cola	250 ml	605 802
mirafluor-k-gel, strawberry	250 ml	605 803

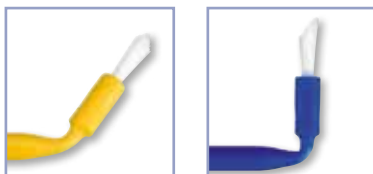

## Mirafluorid®

### Fluoride varnish on emulsion basis with 0.15 % fluoride

- Free of solvents
- For precise application, can also be applied in a humid environment
- Fluoride concentration clearly lower than in comparable varnishes: 0.15 % fluoride
- Aqueous polymer layer allows fluorides to diffuse and is decomposed by the saliva without causing any problems

Article description	REF
Mirafluorid, 5 ml bottle and 20 Mirabrush brushes	605 810
Mirabrush brush (yellow/pointed), 100 pcs.	605 460
Mirabrush brush (blue/flat), 100 pcs.	605 461

Mirabrush brush see page 11.



## Pick up Stick

### Adhesive application aid

- Bendable stick with adhesive wax tip
- Ideal for quick and precise pick-up of crowns, inlays, veneers



Article description	Content	REF
Pick up Stick	30 pcs.	605 423

## PerioMarker

### Oral health rapid test for an early detection of parodontitis and for risk diagnosis

- Preventive: Indicates acute risk of parodontitis before conventional diagnostics
- Painless: Gentle, diagnosis after only 10 minutes
- Delegable: Screening, monitoring and follow-up by dentals assistance
- Successful: For sensitization, motivation and patient recruitment
- Interdisciplinary: To avoid secondary damage for patients with cardiovascular symptoms, diabetics, rheumatic patients, women wishing to become pregnant or heavy smokers
- Parodontal atrophy is detected by measuring the enzyme aMMP-8 (active matrix-metalloproteases)

Article description	Content	REF
PerioMarker	2 separate tests	605 850

Scientific studies on request.

## Myzotect®-Tincture

### Myrrh-Benzoin-Tincture to calm and relieve stressed oral mucosa

- After periodontal or surgical treatment
- Myrrh (tissue-firming and nurturing effect) helps in aftereffects of dental and gingival treatments
- Benzoin is germicidal and antiseptic, while aloe supports the tissue with a nourishing care
- Contains neither antibiotics nor corticosteroids
- No burning after application, sticks to the mucosa for a long time due to its syrupy consistency
- For more than 100 applications

Article description	Content	REF
Myzotect-Tincture	5 ml	155 008
Myzotect-Tincture	50 ml	155 005

#### For the patient's use at home

Article description	Content	REF
Myzotect-Tincture	5 x 5 ml	155 006
Myzotect-Tincture	10 x 5 ml	155 007

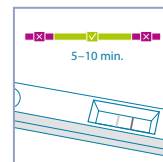
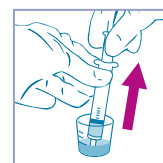
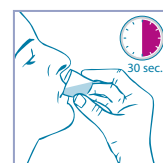

Ideal in combination with Reso-Pac (see page 33)





## Protectoray

### X-ray shield

- X-ray protection shield for the patient
- Safe by 0.5 mm lead lining
- In compliance with DIN 6813
- Approved by the German Institute of Radiation Safety, Munich, Germany
- Convenient for the patient – no heavy lead apron
- Easy exchange of handle



Protectoray wall mount

Article description	REF
Shield and handle	656 127
Wall holder separately transparent	656 128
Wall holder separately blue, silver or white	on request
Handle separately, exchangeable	656 701

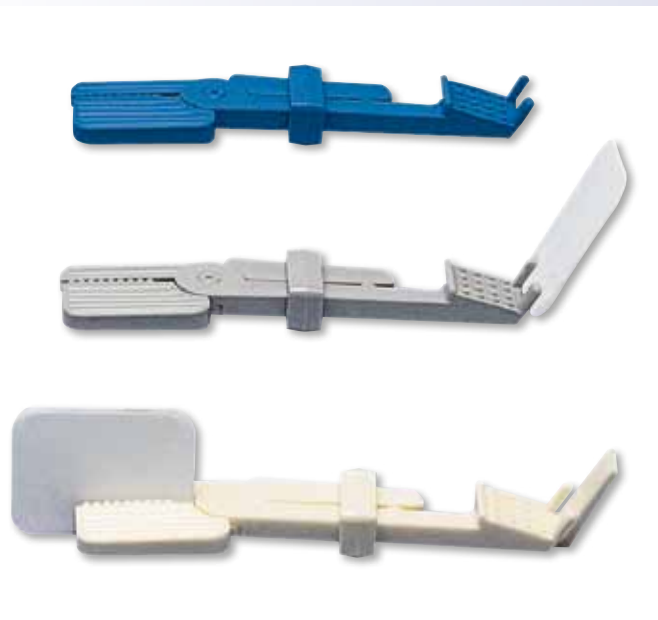

## Emmenix® Film Holder

### Hygienic X-ray film holder

- Film is easily positioned in the patient's mouth without the use of a finger (no irritation of mucosa, no gag reflex)
- Precise, as no bending of the film, no distortion of the picture
- For pictures of anterior teeth and molars, especially wisdom teeth
- Autoclavable, high-quality, unbreakable plastic
- In three colors: white, blue, gray

Article description	REF
Pack with 3 holders, assorted	656 300



## Emmenix® Flap

### Soft bite X-ray cushion

- Special foamed material with high adhesion
- Flap can be fixed to the film optimally and anywhere
- Ideal for bitewing, front, premolar and molar X-ray pictures

Article description	Content	REF
Emmenix Flap	500 pcs.	656 303

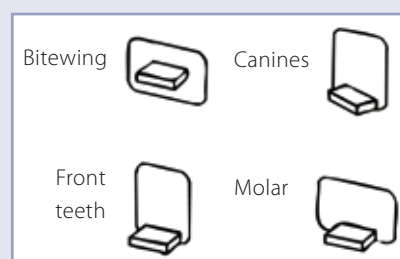

## Salibag

### Protective pouch for X-ray sensors

- Sensor gets inserted in the protective pouch and placed in the patient's mouth for radiography
- Protects the patient, the practice personnel and the sensor against humidity, saliva and blood
- High patient comfort by soft material
- Rounded edges, no risk of irritation
- Size: 36 x 105 mm

Article description	Content	REF
SLB-L, for CCD Sensor S/M	320 pcs.	656 232

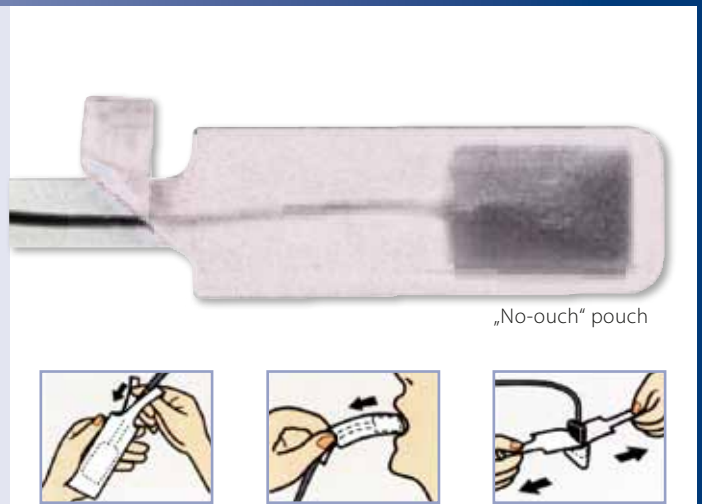

## Panascope

### X-ray film viewer

- For any kind of X-ray picture
- Excellent illumination
- Can be installed as wall or table model
- In accordance with DIN 6856

Article description	Size	REF
Panascope	23 x 40 cm	656 130



## Röntgomarker

### X-ray marking pen

- Waterproof, special white ink
- Very exact, hard and thin tip

Article description	REF
Röntgomarker	656 322



## X-Ray Stain Remover

### Liquid for stain removal

- Highly effective, long-approved
- Removes X-ray chemicals, iodine, rust, etc.

Article description	Content	REF
X-Ray Stain Remover	100 ml	656 220





## OXYSAFE® Gel Professional

Gel for the treatment of periodontitis and peri-implantitis

- Active oxygen gel
- Speeds wound healing (without peroxides or free radicals)
- Reduction of pocket depth
- Simple and precise application
- Free of antibiotics and free of CHX

## OXYSAFE® Liquid Professional

- Active oxygen mouthwash
- Speeds wound healing (without peroxides or free radicals)
- Free of antibiotics and free of CHX

Article description	REF
OXYSAFE Intro Kit, 3 x 1 ml Gel, 3 x 250 ml liquid + 3 x application canulas	155 040
OXYSAFE Gel, 3 syringes à 1 ml (without application tips)	155 041
OXYSAFE Liquid, 250 ml	155 042



First direct application of the gel into the dental pocket



Patient continues treatment at home



Before treatment



Treatment



After treatment

### How does OXYSAFE® Professional work?

OXYSAFE Gel Professional contains the patented Ardox-X® technology, based on active oxygen (hydrocarbon-oxoborate complex) which becomes activated by contact with the skin or mucous membrane. This complex acts as a matrix which releases the active oxygen in the area to be treated. This immediately reduces the number of Gram-negative bacteria. Furthermore, the oxygen-enriched microenvironment has a proven positive effect on the treatment of inflamed gums.

Substances harmful to the body, such as hydrogen peroxides and radicals are not included. The application of OXYSAFE Gel Professional supports the periodontal regeneration therapy of soft tissue that has been damaged by peri-implantitis. OXYSAFE Professional has both, anti-bacterial and anti-fungicidal properties, and supports the regeneration of inflamed tissue due to its increased oxygen content. It protects the oral flora and causes no cell death in erythrocytes or leukocytes. Neither mucosal cells nor osteoblasts are attacked. The effectiveness of OXYSAFE Professional has been confirmed by independent universities and in many studies.

### What is the difference between OXYSAFE® Professional Gel and Liquid?

OXYSAFE Gel Professional is used exclusively by the dentist and gets applied to the gingival pocket. The product is delivered in handy, "ready to use" 1 ml cannulas and is very economical.





OXYSAFE Liquid Professional is a mouthwash used by the patient at home, immediately after treatment as a follow-up. It ensures that enough active oxygen remains in the mouth, maintaining an antibacterial effect and supporting the desired wound healing.



# ACTIVE-OXYGEN BOOSTER

## in periodontitis and peri-implantitis

### OXYSAFE® Professional

-  Treatment of periodontitis and peri-implantitis
-  Eliminates harmful anaerobic bacteria
-  Active oxygen technology speeds wound healing (without peroxides or free radicals)
-  Free of antibiotics and free of CHX



**HÄGER  
WERKEN**



## Plantana®

### Cream for skin care

- Free of mineral oils and silicones
- Free of artificial colors
- Free of animal-derived ingredients
- Free of synthetic perfumes

#### ALOE VERA for normal and sensitive skin

- Easily absorbed by the skin

Article description	Content	REF
Aloe Vera shower gel	500 ml	660 305
Aloe Vera face cream	50 ml	660 308
Aloe Vera body cream	500 ml	660 302

#### OLIVE BUTTER for demanding and dry skin

- Pleasant for people suffering from skin diseases, such as neurodermatitis
- Easily absorbed by the skin

Article description	Content	REF
Olive Butter shower gel	500 ml	660 303
Olive Butter face cream	50 ml	660 306
Olive Butter body cream	500 ml	660 300

#### SHEA BUTTER for demanding and dry skin

- Rich and easily absorbed by the skin

Article description	Content	REF
Shea Butter shower gel	500 ml	660 304
Shea Butter face cream	50 ml	660 307
Shea Butter body cream	500 ml	660 301

## Plantana® Lip Balm

### For natural soft lips

- Cares and protects
- With nourishing Sheabutter, protecting Jojobaoil and regenerating Aloe Vera
- With vanilla fragrance

Article description	REF
Plantana Lip Balm, jar 5 g	660 318
Plantana Lip Balm display, 20 jars	660 319



5 g

## Mira-Duo

### Double-sided patient mirror

- Front 1:1, back twofold magnification
- ø 13 cm
- Can be used as hand or table mirror
- Ideal for control – especially in prophylaxis

Article description	REF
Mira-Duo	605 682



## McTooth Mirror

### Molar-shaped pop-up mirror

- For prophylaxis in children and adults
- Size ca. 17 x 14 cm

Article description	REF
McTooth Mirror	707 094



## Membranbox Medium

### Patented transport and storage box

- With two elastic, transparent membranes
- Ideal storage to safely send pieces of high-quality work
- Long durability due to high-quality material
- Stackable

Article description	REF
Medium: for bridges, partial dentures, attachments, etc.	304 602



Medium (W x H x D):  
8.5 x 2.2 x 9 cm



Small (W x H x D):  
4 x 1.9 x 4 cm

## Membranbox Small and XXL

### Transport and storage box with inside membranes

- Two membrane foils hold the contents gently and well visible
- Safety lock
- No rattling due to two membrane foils gently holding even smallest pieces
- Stackable

Article description	REF
Small: set with 12 pcs. for crowns, inlays, etc.	304 603
XXL: for 2 models	304 605



XXL (W x H x D):  
19.2 x 4.8 x 9.2 cm

## Dento Box® I + II

### Solid transport and storage box

- For prosthesis, orthodontic works, etc.
- Impact-proof, safe snap lock and small ventilation holes
- Ideal advertising medium with your name and address (from 500 pcs.)

**This article can be delivered with your advertising imprint.  
Please ask for a quotation.**

Article description	Content	REF
Dento Box I, white	12 pcs.	355 148
Dento Box II, white	10 pcs.	355 141
Dento Box II, blue	10 pcs.	355 142
Dento Box II, pink	10 pcs.	355 143



Dento Box I: height 2.5 cm

Dento Box II: height 4 cm

For Dento Box with hang cord see page 88.



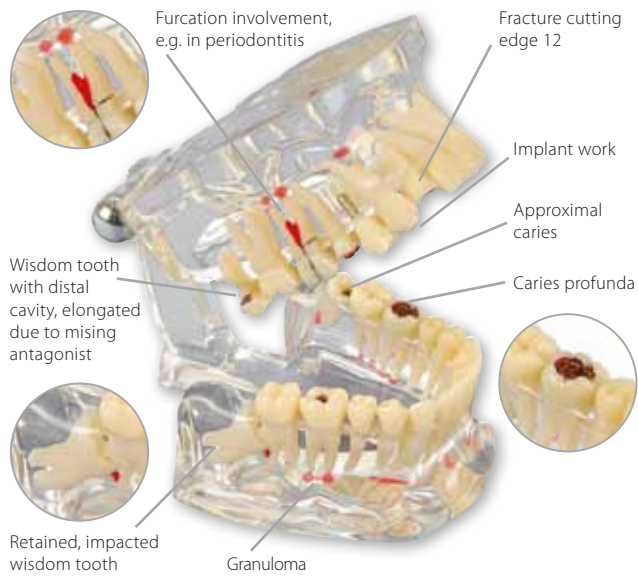

## Study Model Transparent De Luxe

### Demonstration model adult with tooth diseases

- Maxilla and mandible feature various of tooth defects, courses of carious defects malocclusion of lower wisdom teeth
- Several examples of inflammatory root processes
- Illustration of an implant work with build-up
- Teeth not removable, scale 1:1



## Study Model Transparent Plus

- Demonstration of various tooth defects and courses of carious defects
- Teeth not removable
- Scale 1:1

Article description	REF
Study Model Transparent Plus	355 640
Study Model Transparent De Luxe	355 642



## Study Model Transparent

### High-quality transparent demonstration model

- All 32 teeth can be removed from the alveole
- Well visible root anatomy
- Made of transparent, solid plastic
- Scale 1:1

Article description	REF
Study Model Transparent	355 641



## Study Model Demo Implant C+B

### Transparent demonstration model of various prosthetic works

- Demonstration of various in-/onlays and implant works
- 11 removable works for patient information
- Made of solid and transparent polymer material
- Scale 1:1

Article description	REF
Study Model Demo Implant C+B	355 638
Replacement restorations (11 pcs.)	355 639

## Study Model Transparent Child

### Demonstration model Child

- Very clear illustration of deciduous and permanent teeth
- Maxilla and mandible with ten deciduous teeth
- With broken deciduous front tooth with root disease
- Scale 1:1

Article description	REF
Study Model Transparent Child	355 643

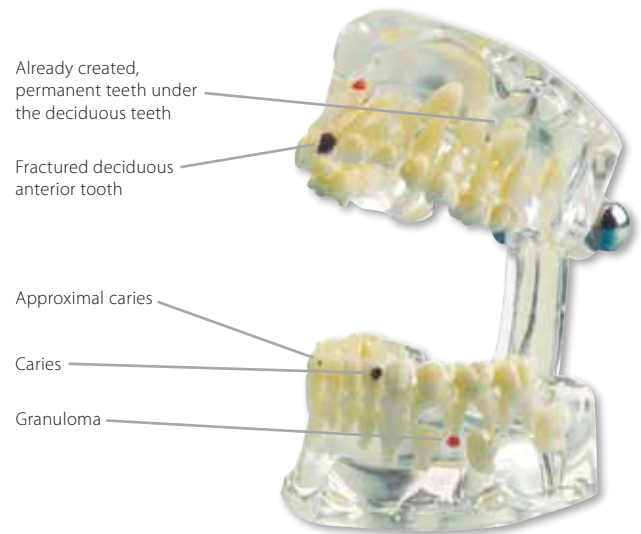

## Study Model ORTHO-Brackets

### Demonstration model with brackets

- Patient information for orthodontic treatments
- Color-coded ceramic and metal brackets
- Removable bracket rubber bands
- Transparent, pinkish plastic

Article description	REF
Study Model ORTHO-Brackets	355 645



## Toothbrushing Model

### Enlarged demonstration model

- For demonstration of the correct brushing technique
- With oversized toothbrush
- Ideal for motivation of children



Article description	REF
Model incl. super-brush	355 636
Super-brush separately	355 637







## Putzi-Pets

### Hand puppets with denture

- The ideal aid to motivate children
- For explanation of appropriate dental care
- Special effect: With the small water bottle, the puppets turn into water pistols
- Dimensions: W x H x D: approx. 17 cm x 28 cm x 15 cm

Article description	REF
Putzi Croc (6)	707 045
Putzi Dino (1)	707 046
Putzi Cow (2)	707 047
Putzi Horse (5)	707 048
Putzi Dragon (3)	707 092
Putzi Tiger (4)	707 093



## Putzi-Buddys

### Big hand puppets with denture

- Dimensions: W x H x D: approx. 25 cm x 38 cm x 18 cm



Article description	REF
Cow Berta	707 081
Teddy Bear	707 083
Horse Jimmy	707 084



## Miratoi® No. 3

### Farm Set

- Various farm animals



Article description	Content	REF
Miratoi No. 3, assorted	100 pcs.	605 692



## Miratoi® No. 4

### Zoo Set

- Various zoo animals



Article description	Content	REF
Miratoi No. 4, assorted	100 pcs.	605 693

## Miratoi® No. 1

### Mixed assortment

- Cars, boats, combs etc.



Article description	Content	REF
Miratoi No. 1, assorted	150 pcs.	605 690



## Miratoi® No. 6

### Finger rings

- Lovely finger rings in various sizes



Article description	Content	REF
Miratoi No. 6, assorted	100 pcs.	605 694



## Miratoi® No. 7

### Watches

- Puzzle in the shape of watches in various colors



Puzzle

Article description	Content	REF
Miratoi No. 7, assorted	80 pcs.	605 695



## Miratoi® No. 8

### Bouncy balls

- Funny bouncy balls in various colors
- ø 2.5 cm



Article description	Content	REF
Miratoi No. 8, assorted	100 pcs.	605 696



## Miratoi® No. 10

### Miniature cars and boats

- Miniature cars and boats in various colors



Article description	Content	REF
Miratoi No. 10, assorted	100 pcs.	605 698





## Miratoi® No. 12

### Medal set

- Special award as motivation for brave young patients
- Stamped medal with ribbon
- Made of plastic



Certificates in different languages available on request:

D - GB - F - E - IT - NL - HR - SRB - MK - P

Package with 50 medals and 50 certificates

Article description	Content	REF
Miratoi No. 12	50 pcs.	605 706



## Miratoi® No. 13

### Treasure chests

- Ideal for the safekeeping of deciduous teeth



Article description	Content	REF
Miratoi No. 13	100 pcs.	605 699



## Miratoi® No. 15

### Mini ponies

- For combing and cuddling
- In five colors



Article description	Content	REF
Miratoi No. 15, assorted	50 pcs.	605 701

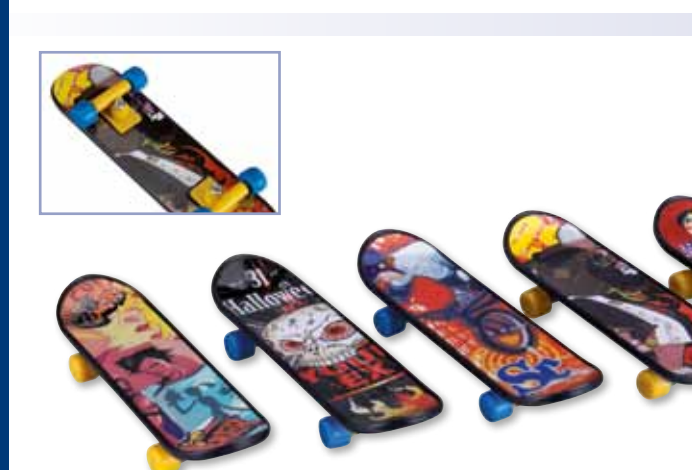

## Miratoi® No. 17

### Fingerboards

- Ultimate fingerboards in five cool designs



Article description	Content	REF
Miratoi No. 17, assorted	50 pcs.	605 707



## Miratoi® No. 19

### Snap-on bracelets

- Reflecting bracelets increase the visibility in the dark
- Snap-on bracelets automatically bend under slight pressure and adjust to any wrist girth
- Well suited for cyclists and joggers
- Size: L x W: 21 x 2.5 cm



Article description	Content	REF
Snap-on bracelets	50 pcs.	605 702

## Miratoi® No. 20

### Glider for brave patients

- Glider made of polystyrene
- 5 different versions
- Glides through the air effortlessly
- Length per glider: ca. 20 cm
- With propeller for good flying characteristics
- Not suitable for children younger than 3 years of age
- Content: 50 individually wrapped gliders

Article description	Content	REF
Miratoi No. 20, assorted	50 pcs.	605 704



## Tooth Coin Bank

### Tooth-shaped coin bank

- Solid ceramic-like material
- Large opening, also suitable for bills
- With reclosable opening at the bottom

Article description	REF
Tooth Coin Bank	707 105



## Anti-Stress Tooth

### Effective relaxation aid

- By squeezing the tooth, the patient gets pleasantly distracted
- Ideal for stress relaxation or as a gift
- Dimensions: 64 x 54 x 38.5 mm, weight: 42 g
- Material: polyurethane

Article description	REF
Anti-Stress Tooth	707 002







Standard

High

Standard + back rest

### Premium quality, standard colors



Black II

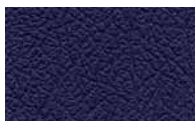

Atlantic Blue IV



Grey II



Heron II



White Vellum II



Cream II



Poppy II



Tan II



Merlin Blue III

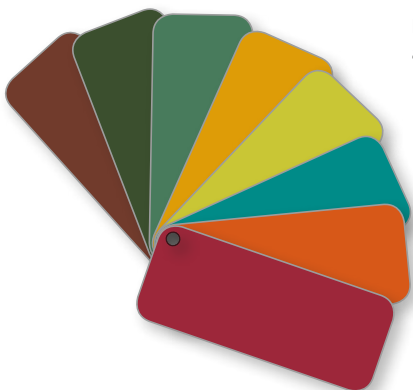

Every special color available upon request

Notice!  
Actual colors may vary.

## Bambach Saddle Seat®

### Ergonomically constructed seat

- Patented saddle shape with bulged back
- Adjustable in height and tiltable seat surface
- Covered with premium leather (optional in vinyl)
- Prevents and cures back pain, significantly reduces the spinal strain
- Keeps the natural sitting position of pelvis and spinal column
- Thanks to the seat's inclination adjustment: Upright pelvis position and straight back, also when bending forward to sitting work posture on the patient



**X** Changes your posture



**✓** Changes your life

The seat is available in various heights to match everybody's height:

Height of gas lift	S	M	L
Body height	up to 1.60 m	up to 1.90 m	over 1.90 m

(Please consider, when ordering)

Premium quality standard colors	Without back rest*	With back rest
White Vellum II	460 004	460 021
Heron II	460 006	460 023
Black II	460 007	460 024
Merlin Blue III	460 012	460 319
Cream II	460 056	460 318
Atlantic Blue IV	460 200	460 300
Grey II	460 203	460 303
Poppy II	460 211	460 311
Tan II	460 220	460 316

\* cannot be assembled post hoc



## Bambach Saddle Seat® Cutaway

### Ergonomically constructed seat

- With a particularly narrow bulge
- Comfortable for women with narrow hips

The seat is available in various heights to match everybody's height:

Height of gas lift	S	M	L
Body height	up to 1.60 m	up to 1.90 m	over 1.90 m

(Please consider, when ordering)

Article description	Color	REF
Bambach Cutaway	black	460 515



Colors and article numbers upon request

## Bambach® Armrests

### Relieving, particularly during long treatments

- Perfect for long treatments, such as in endodontics and surgeries
- Relieves shoulder muscles
- Swivel-mounted armrest can be equipped post hoc
- Available in two versions:  
Short armrest (length 30cm) Long armrest (length 55cm)

Article description	Length	REF
Armrest, long (bent)	55 cm	460 800
Armrest, short (straight)	30 cm	460 801



Please state the desired color and if the assembling is favored on the right or left side. Color samples available upon request.

## Bambach® Foot Height Adjuster

### Foot operated height adjuster

- Sitting height can be adjusted in an easy and hygienic way, leaving (your) hands free
- Quick change of position
- Perfect for surgeries and long treatments
- Stainless steel
- Suitable for gas lift (stems) large and medium

Article description	REF
Foot height adjuster large	901 239
Foot height adjuster medium	901 245



## Bambach® OP

### Seat particularly for operation theatres

- In correspondence with the hygienic guidelines in operation theatres
- Can be completely disinfected
- Height can be adjusted hygienically, leaving your hands free
- Foot height adjuster
- Top with adjustable tilt angle
- Back pain prevention and elimination
- Top made of polyethylene
- Cradle, gas lift and base made of stainless steel

Article description	Color	REF
Bambach OP	black	460 100



## Bambach® Leather Care Oil

### Intensive care and protection of leather surfaces

- Long-acting, keeps leather surfaces soft and smooth

Article description	Content	REF
Leather care oil	50 ml	554 304



We recommend a cleaning and disinfection prior to using the Bambach leather care oil.



	For all applications:		
	Laser	HF	LaserHF
Oral surgery	●	●	●
Periodontology	●	●	●
Implantology	●	●	●
Endodontics	●	●	●
Bleaching	●	●	●
aPDT	●	●	●
LLLT	●	●	●

### Radio Frequency Surgery: Optimal Cutting and Coagulation

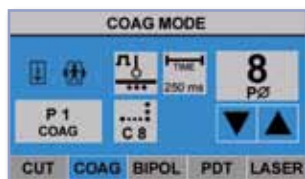
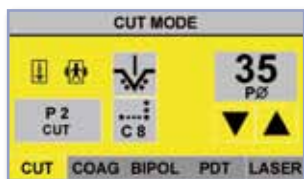

### Diode laser 975 nm/8 W: Parodontology, Endo- dontology and more

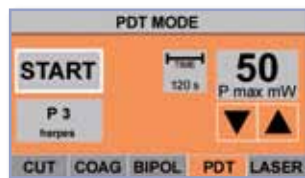
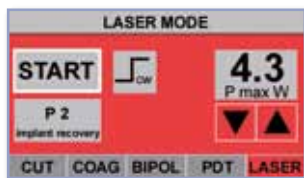

## LaserHF®

### Laser and HF technology combination device

- I-Cube design with touch screen control
- Preset programs for all possible applications
- Individual control available additionally
- Highest possible functionality and hygiene
- Touch screen monitor for easy operation and selection of programs

### LASER:

- Disinfection and cleaning of gingival pockets in periodontosis
- Disinfection after root canal preparation in endodontics
- Removal of soft tissue, e.g. in implant surgery in peri-implantitis
- Wound healing, pain relief and desensitisation by Low Level Laser Therapy (LLLT)
- PDT laser (photodynamic therapy)
- Optionally: accelerated bleaching by laser therapy

### RADIO FREQUENCY:

- Two hand pieces working independently of each other for exchangeable electrodes (color-coded): cutting- and cutting-/coagulation wave (yellow), coagulation wave (blue)
- All type of treatments are possible due to the three forms of frequency: Cutting, cutting with coagulation for haemostasis, coagulation, pulse-driven coagulation to gently weld small tissue pieces
- Automatic voltage control
- hf Bipolar forceps optionally available
- Hand piece and electrodes are autoclavable at 134 °C

### Technical data:

HF power max. 50 W  
 HF frequency 2.2 MHz  
 Laser PDT: 660 nm/100 mW  
 Laser 975 nm/8 W - cw/pulsed  
 Measures (WxHxD) 30 x 13 x 25 cm  
 Power supply 230V/50Hz  
 HF 2.2 MHz/50 W – monopolar/bipolar  
 Weight ca. 3.5 kg



User report

### Basic equipment:

2 laser hand pieces (red for 8 W laser, orange for softlaser)  
 1 x fiber tip 200 µm + 1 x fiber tip 320 µm  
 Safety glasses Lambda One (800 – 975 nm)  
 Over-spec Skyline (green, 800 – 975 nm)  
 Over-spec Skyline (blue, 657 – 660 nm)  
 Patient's safety glasses  
 2 HF hand pieces (autoclavable)  
 Set of electrodes (Nos. 40, 2, 13, 15, 31, 33)  
 Neutral electrode, door contact/interlock, foot pedal  
 Instructions for use, medical product journal



Video

hf Bipolar Forceps to be ordered separately!

### The standard LaserHF device is still available.

Article description	REF
LaserHF Standard with 2.5 m glass fiber	452 462
hf Bipolar-Forceps see page 64	



## hf1 Surg bipolar

### Universal HF surgery device

- Preset programs for all possible applications
- Additionally offers individual programming
- Standard fitting: connection for bipolar forceps
- Highest possible functionality and hygiene
- Touch screen monitor for easy operation and program selection
- Two individually working hand pieces for exchangeable electrodes (color marked): cutting and cutting/coagulation wave (yellow), coagulation wave (blue)
- Every application is possible due to three frequency forms: cutting, cutting with coagulation for haemostasis, coagulation, pulsed coagulation for gentle welding of smaller tissue particles
- Automatic voltage regulation
- Bipolar forceps optionally available
- Hand piece and electrodes are autoclavable at 134 °C

#### Scope of delivery:

Device with 2 autoclavable hand pieces, foot pedal, set of electrodes (6 pieces: Nos. 40, 2, 15, 13, 31, 33), neutral electrode

hf Bipolar Forceps to be ordered separately!

#### Frequency + power:

2.2 MHz, max. 50 W  
Voltage: 230 V/50 Hz  
Unipolar and bipolar  
Permanent/pulsed

#### Measures + weights

W 21.5 x H 11.7 x D 25 cm  
Weight 2.65 kg

Article description	REF
hf1 Surg bipolar	452 459
hf Bipolar-Forceps see page 64	

For Laser protective glasses see page 65

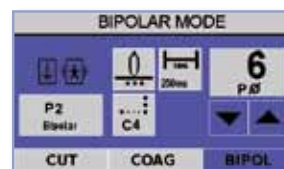
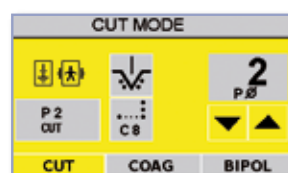

Source: Prof. Dr. med. Frank Liebaug

## hf Surg®

### Low priced and sophisticated radio surgery unit

- For scalpell fine, pressureless incisions- frequency control enables cut and cut/coagulation for haemostasis
- Fast and painless wound healing
- Highest possible functionality and hygiene
- Easy handling of the analog intensity control and frequency switch
- Automatic output management, fail safe mechanism when in contact with metal
- Hand piece and electrodes are autoclavable at 134 °C

#### Scope of delivery:

Device with foot pedal, hand piece, 4 electrodes and neutral electrode

hf Bipolar-Forceps to be ordered separately!

#### Frequency + power

2.2 MHz, max. 50 W  
Voltage: 230 V/50 Hz

#### Measures + weights

W 19 x H 9 x D 18 cm  
approx. 1.6 kg

Article description	REF
hf Surg	452 400

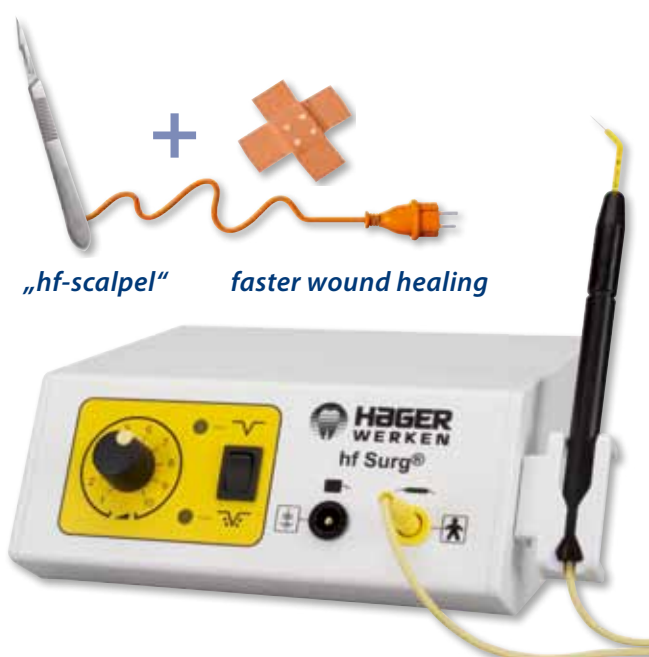



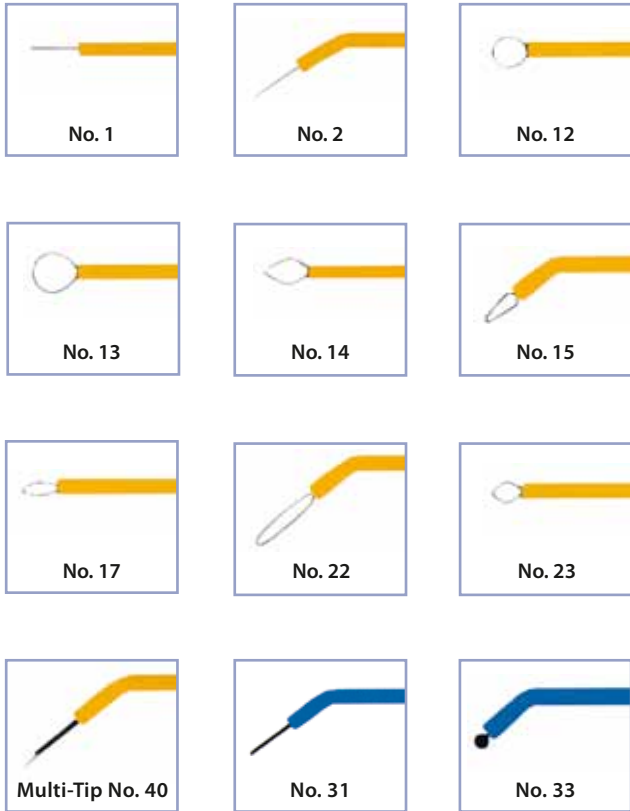

## hf Electrodes

Article description	REF
hf cutting electrode No. 1, yellow	452 403
hf cutting electrode No. 2, yellow	452 404
hf cutting electrode No. 12, yellow	452 410
hf cutting electrode No. 13, yellow	452 411
hf cutting electrode No. 14, yellow	452 409
hf cutting electrode No. 15, yellow	452 407
hf cutting electrode No. 17, yellow	452 405
hf cutting electrode No. 22, yellow	452 406
hf cutting electrode No. 23, yellow	452 408
hf cutting electrode Multi-Tip No. 40, yellow	452 402
hf coagulation electrode No. 31, blue	452 415
hf coagulation electrode Nr. 33, blue	452 416



## hf Neutral Electrode

Coated earth plate for optimal conduction of the hf waves

- Disinfectable
- Please mention the serial number of your old appliance!
- Further equipment available on request!

Article description	REF
Length 1.50 m	452 421



## hf Bipolar-Forceps

Special forceps connection for the hf Surg devices

- Available in two lengths and shapes, without cable
- Can be sterilized
- Ideal for surgical dentists, e.g. in achieving hemostasis

**Please note:** For first equipping, the hf Bipolar cable needs to be ordered separately. Not included in the scope of delivery.

Article description	Form of Delivery	REF
hf Bipolar-Forceps	110 mm straight	452 446
hf Bipolar-Forceps	110 mm angulated	452 447
hf Bipolar-Forceps	160 mm straight	452 448
hf Bipolar-Forceps	160 mm angulated	452 455
Cable for Bipolar-Forceps	1.50 m	452 456

## LaserHF® PDT Solutions

### PDT-solution for disinfection

- Specifically for the treatment with the LaserHF „comfort“
- Photo-activated disinfection of root canals, periodontal pockets and for treatment of peri-implantitis
- For Laser 660 nm, Fiber 320 µm

Article description	Content	REF
LaserHF Endo-PDT solution	3 syringes à 0.8 ml	155 030
LaserHF Paro-PDT solution	3 syringes à 1.2 ml	155 031



## Mirawhite® Laser Bleaching

### Dental bleaching gel for use with diode laser

- Bleaching gel adapted for wave lengths
- For diode lasers 810 – 980 nm
- Two component bleaching gel in a 5g mixing cartridge
- With 35% hydrogen peroxide concentration for highly effective bleaching and brightening of vital and devital teeth

(When using in combination with the LaserHF device, the bleaching gel gets activated with the special LaserHF bleaching hand piece (REF 452 472).

**Set consists of:** 1 bleaching-gel cartridge with 35 % hydrogen peroxide 5 g, 3 mixing tips, 1 syringe with gingiva protector 1 ml, 1 syringe with afterbleach care 2 ml, 2 applicators

Article description	REF
Mirawhite Laser Bleaching	607 086



## laservision

### Laser protective glasses in modern design

- (1) Lambda One: certified safety grade LB4, for Laser 800 – 1064 nm\*, 27 g
- (2) laservision green: over the glasses with the same properties, 51 g
- (3) laservision blue: over the glasses for diode-softlaser 657 – 660 nm\*, 51 g
- (4) Glasses for patient: good fit through flexible frame, high protection levels

Article description	REF
(1) laservision Lambda One	355 630
(2) laservision green	355 631
(3) laservision blue	355 632
(4) laservision safety glasses for patient (in laser treatments)	355 633

\* All of our glasses are LaserHF compatible. Should you use another laser, please calculate the safety grades your laser requires and compare them with the information stated on the laser safety glasses, before using them.





## Integra® Cart Smart

### Cost-friendly 3 surface cart

- 2 universal electrical sockets
- 2 trays with rim protection
- Maximum load per tray 10 kg

**Dimensions:** (W x H x D): 35 x 78 x 45 cm, weight: 14.5 kg

Article description	REF
Integra Cart Smart	460 120

## Integra® Cart De Luxe I - III

### Multifunction cart in three models

- New: compressed air connection below the first tray (self locking compressed-air coupling)
- New: the center tray is height-adjustable
- Easy-running and antistatic castors for quick and easy shifting of the unit
- Castors can be locked

#### Integra Cart De Luxe I

**Overall dimensions:** (W x H x D): 40 x 75.5 x 49.5 cm, weight: 18.8 kg

#### Integra Cart De Luxe II

- Same as model De Luxe, but center tray is equipped with a material drawer
- Drawer top is designed as a tray and can be used as deposit surface for small equipment

**Overall dimensions:** (W x H x D): 40 x 75,5 x 50 cm, weight: 22.8 kg

Article description	REF
Integra Cart De Luxe I (not shown)	460 115
Integra Cart De Luxe II	460 116
Integra Cart De Luxe III with two drawers (not shown)	460 117



## Integra® Cart Fit-On Tray

### Tray for the column of surgery lamp

- Suitable for all accessory devices (e. g. hf1 Surg bipolar), which are needed chairside
- Rotatable by two swivel-joints
- Handle mountable on long or short side
- Elegant and easy to mount to all columns
- Solid metal tray, max. load 6 kg, color RAL 9002

#### Dimensions:

Outside (W x D): 35 x 26 cm  
 Inside (W x D): 33.5 x 24.5 cm  
 Swivel arm: 23 cm long

Article description	REF
Integra Cart Fit-On Tray with standard arm	460 103

**The Fit-On Tray has to be ordered together with the fitting pipe flange to allow for mounting.**

Pipe flange incl. internal ring	ø	REF
For Planmeca	42 mm	460 104
For Ritter	48 mm	460 106
For Eurodent	50 mm	460 107
For Sirona/Siemens	52 mm	460 108
For Kavo/Flex Integral	55 mm	460 109
For Ultradent/Faro	60 mm	460 110
For other units	45 mm	460 105



# Hager Outbacks

## Protection and elegance at work

- Modern polishing techniques reduce distortions
- Fog reduction is the effect of a special ventilation system
- Light weight frame prevents pressure on head and ears
- Silicone nose piece prevents sliding
- Silicone grips on temples
- Each pair includes a free neck strap (black)

Frame	Lens	REF
Black	clear	304 702
Hot Pink	clear	304 703
Purple	clear	304 705
Blue	clear	304 706
Neck strap black, separately		304 711



Hot Pink



Blue



Hot Pink

25 g



Purple



Black





30 g



## Hager iSpec® Pure Fit

Trendy protective glasses with wide field of view and perfect all-around vision

- Dual spherical protective glass offers ideal coverage of the eyes even in the area of the eyebrows
- Temple with integrated „climate-zone technology“ ensures you can work longer without fatigue
- High wearing comfort due to non-slip components
- Especially for slender faces: uvex Pheos small
- Coating: Outside extremely scratch-resistant, inside anti-fog coating

Frame	Lens	REF
Light gray/gray	clear	355 607
Black/green	clear	355 608
Black/orange	gray	355 609
Small: white/green	clear	355 610
Small: anthrazit/gray	clear	355 611



## Hager iSpec® Pure Fit II

Nonslip and comfortable

- Modern, sporty design
- Very comfortable and with soft temple and nose contact
- Optimal protection by twist side technology and nonslip
- Large field of vision due to duo-spheric glasses

Frame	Lense	REF
Blue	clear	355 627
Red	clear	355 628



27 g



30 g

## Hager iSpec® Softflex Fit

Innovative protective glasses optimally adjusting to any face

- Individually adjustable sides with multilevel inclination
- Excellent wearing comfort no matter the head size, due to integrated Softflex-zone
- Soft Softflex nosebridge offers comfortable, pressure-free fit and avoids annoying slipping
- Soft temples and Softflex-zone in the forehead area ensure a secure hold

Frame	Lens	REF
Anthrazit/blue	gray	355 613



## Hager iSpec® Classic Fit

Stylish and slim protective glasses

- Protective glasses with unobstructed side view
- Especially suitable for slender head shapes
- Length and angle of sides individually adjustable
- Excellent chemical resistance



61 g

Frame	Lens	REF
Red/black	clear	355 564



## Hager iSpec® Sunshine Fit

Attractive leisure eye wear with same design as uvex Astrospec

- Without fog resistant lens, sun protection grade 5-2,5

Frame	Lens	REF
Yellow/black	tinted	355 526



63 g

## Hager iSpec® Safety Fit

Original design and maximum safety

- All-around view
- Temple length and angle individually adjustable
- Pressure-free fit

Frame	Lens	REF
White	clear	355 518
Replacement lens	clear	355 521
Neck strap black		355 520



## Hager iSpec® Safety Fit II

Optimum eye coverage and large panorama lenses

- Variable side arm inclination (3 notches)
- Maximum wearer comfort for all face shapes due to flexible 2K side arms technology
- Optimal ventilation due to labyrinth seal
- Folds flat and fits into all pockets
- Coating: extremely scratch-resistant, inside anti-fog coating

Frame	Lens	REF
Blue	clear	355 624
Lime	clear	355 625



43 g





30 g



38 g



## Hager iSpec® Flexi Fit

Fashionable, flexible protective glasses

- Excellent safety due to side protection
- Adjustable temple lengths
- Coating: extremely scratch-resistant, inside anti-fog coating

Frame	Lens	REF
Black	clear	355 572
Blue	clear	355 573
Replacement lens	clear	355 574
Replacement lens without anti-fog coating	tinted	355 575

## Hager iSpec® Flexi Fit II

Extremely lightweight and fashionable protective eyewear

- Lens and frame made of high-impact plastic
- Additional side protection against dazzling
- Soft temples, individually adjustable
- Also ideal in sport and leisure time activities
- Coating: extremely scratch-resistant, inside anti-fog coating

Frame	Lens	REF
Blue	clear	355 580
Blue translucent	clear	355 585
Replacement lens	clear	355 586

## Hager iSpec® X Fit

Extreme light and modern safety glasses

- Anatomically shaped wrap-around lens
- Extreme wide peripheral and highly protected field of vision
- 20 % larger coverage versus regular temple glasses
- Coating: outside extremely scratch-resistant, inside anti-fog coating



58 g

Frame	Lens	REF
Black	gray	355 598
Black	tinted	355 599





## Hager iSpec® Super Lite Fit

The world's lightest protective eyewear

- Innovative, flexible temple concept
- X-stream technology for highest wearing comfort
- Aerodynamically optimized and inclined lens geometry
- Coating: outside extremely scratch-resistant, inside anti-fog coating



Frame	Lens	REF
Titan	gray	355 600
Crystal	clear	355 601
Navy blue	clear	355 602
Replacement lens	clear	355 603

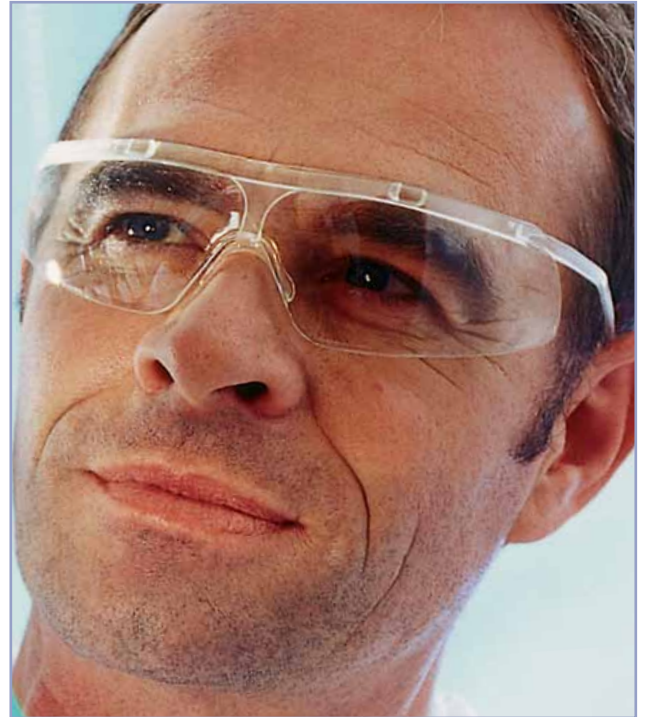

## Hager iSpec® Comfort Fit

Fashionable multi-component protective eyewear

- High wearing comfort through hard/soft components
- Temple length individually adjustable
- Coating: outside extremely scratch-resistant, inside anti-fog coating
- Brown lens is chemical resistant

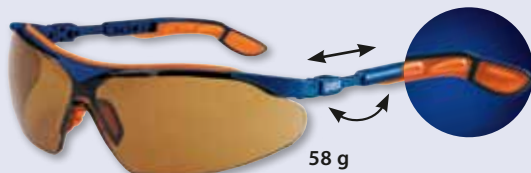

Frame	Lens	REF
Blue/orange	brown*	355 590
Blue/gray	clear	355 589

Replacement lenses brown\* and clear on request

\* no anti-fog coating



## Hager iSpec® BT Fit

Extremely light and safe protective eyewear

- Fits over all prescription glasses
- Wrap-around lens with 180° field of vision
- Excellent, pressureless fit
- Efficient lateral ventilation
- New temple length and easy adjustment of inclination

Frame	Lens	REF
Clear	clear	304 424







## Hager iSpec® Slim Fit

Safety glasses for best all-round visibility

- Large wrap-around lenses for maximal field of view
- Pressure-free and comfortable to wear
- Coating: outside extremely scratch-resistant, inside permanently mist-free
- Weight: 21 g

Frame	Lens	REF
White	clear	304 428



## Hager iSpec® Slim Fit UV

UV protective eyewear

- Safe protection against UV radiation in extended wavelength range of 350 – 523 nm
- For all light polymerization units
- Tested by NIOM (Nordic Institute of Dental Materials)
- Coating: outside extremely scratch-resistant, inside mist-free
- Weight: 21 g

Frame	Lens	REF
White	orange	304 427



21 g

## Hager iSpec® Steril Fit

Autoclavable safety eyewear

- Unique autoclavable glasses with anti-fog performance
- High wearer comfort due to soft temples
- Can be autoclaved up to 10 times at 121 °C
- Coating: extremely scratch-resistant, inside anti-fog coating



39 g

## Hager iSpec® Steril Fit OTG

- OTG suitable for persons wearing glasses

Frame	Lens	REF
Hager iSpec Steril Fit, white / blue	clear	355 510
Hager iSpec Steril Fit OTG, white / blue	clear	355 511



## Hager iSpec® Fit OTG

Lightweight over-the-glass all-around protective eyewear

- No contact of temples with the prescription glasses
- Good coverage of the eye area by flat basic curve
- Soft, extra flexible temple tips
- For ideal, visual image quality
- Weight: 37 g

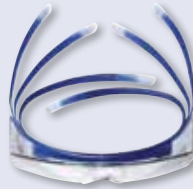

Frame	Lens	REF
Blue	clear UV 2C-1.2	355 539



## Proto-Cam®

Face shield



- Made of non-reflecting polycarbonate
- Lightweight frame for fixing to the head (25 g)
- Ideal for works with prophylaxis blasting units
- Avoids infection risk from patients

Article description	REF
White frame with 5 replacement shields	355 535
Transparent blue frame with 5 replacement shields	355 546
Pack with 5 replacement shields	355 536



## CC-Shield

Face shield



- Highly impact-resistant and can be hinged upwards
- Fits any head size – adjustable Velcro fastening
- No light or color reflex
- For working in the laboratory, etc.

Article description	REF
CC-Shield	355 508



## Astro Clean®

Spray disinfection

- Particularly for disinfection of protective (Hager iSpec) glasses
- No damage to the anti-fog coating
- Generally usable for all surfaces in the medical field
- Bactericidal, fungicidal and virus-inactivating (HBV and HIV)

Article description	Content	REF
Astro Clean	250 ml	554 301





28 g

## H&W Classic

### Stylish and comfortable protective eyewear

- Soft sides, adjustable with lock-in-place extension
- Provides full protection with 180° unobstructed view
- Anti-fog and anti-scratch clear lens with HC/AF coating
- 100 % impact resistant polycarbonate lens

Article description	REF
H&W Classic	355 622



24 g

## H&W Panorama

### Safety glass with panorama view and side protection

- Ergonomic temples
- Nose bridge of soft and anti-slip rubber
- Anti-fog and anti-scratch clear lens with HC/AF coating

Article description	REF
H&W Panorama	355 620



22 g

## H&W Featherlight

### Ultra-lightweight protective eyewear

- Soft temples with adjustable notches
- Adjustable soft nosepiece for a superior anti-slip fit
- Comfortable full wrap-around protection
- Anti-fog and anti-scratch clear lens with HC/AF coating
- Polycarbonate lens

Article description	REF
H&W Featherlight	355 621



## H&W Kids Protect

### Ergonomic protective eyewear for children

- Most helpful protection in treatment for children aged 4 - 10
- Comfortable and child-friendly fit
- Easily adapts to slender-headed forms
- Lightweight 17 g

Article description	REF
H&W Kids Protect	355 635

## H&W Sports Pro

### Safety glasses with anti-slip nose bridge

- Temple length individually adjustable
- Adjustable soft nosepiece for a superior anti-slip fit
- Comfortable full wrap-around protection
- Weight: 30 g

Article description	REF
H&W Sports Pro	355 619



## H&W OTG II

### Panorama overspecs

- No contact of temples with the prescription glasses
- Good coverage of the eye area
- Weight: 38 g

Article description	REF
H&W OTG II	355 618



## H&W Logic

### Temple length individually adjustable

- All-around view
- Weight: 32 g

Article description	REF
H&W Logic	355 616



## H&W Panorama II

### For slender faces

- Ergonomic temples
- Weight: 25 g

Article description	REF
H&W Panorama II	355 617



## H&W Super Fit UV (OTG)

### Over-the-glasses eyewear with large field of view

- Suitable for works with polymerization lamps (390-525 nm)
- Softpad technology assures ideal, ergonomic fit
- Unobstructed view to the sides
- Temple length adjustable
- Weight: 38 g

Article description	REF
H&W Super Fit UV (OTG)	355 626







**Ingredients:** Sweetener: Xylitol; stabiliser: isomalt; thickening agent: gum arabic; flavor; strawberry extract; acidity regulator: calcium lactate; acidifying agent: citric acid; separating agent: magnesium stearate; colouring agent: beetroot red

## From the practice for the practice

**Dear Dental Practitioners,**

Our miradent products are available through the dental specialist trade, but also in every pharmacy, so that your interested patients can easily purchase them. Of course, the miradent products also represent an ideal complement to the range of your prophylaxis shop. Detailed information on our products can also be found here:

[www.miradent.de](http://www.miradent.de)

## XyliPOP® Lolli

Lollipop sweetened with Xylitol – sugar free!

- With Xylitol and calcium lactate
- Free of aspartame, sorbitol, lactose and gluten
- Motivation and fun within child prophylaxis
- Also great for adults
- Fruity-fresh strawberry flavor

Article description		REF
XyliPOP Lolli strawberry	6 g	630 208
XyliPOP Lolli strawberry	Bonboniere with 25 x 6 g	635 213
XyliPOP Lolli strawberry	Box with 50 x 6 g	635 214



Excessive consumption may produce laxative effects.

## Xylitol Powder

Xylitol – a 100 % natural and healthy sugar substitute



- For sweetening cold and hot drinks, fruit, cereals or for baking
- Ideal for a balanced and healthy diet
- Same sweetening effect as sugar
- Purely natural product, gluten-free and not genetically modified
- 40 % less calories than saccharine

Article description	Content	REF
Xylitol Powder	350 g	630 119
Xylitol Powder	100 x 4 g	630 120
Xylitol Powder (see page 91)	5 x 350 g	635 080



## Aquamed®

Helps in case of dry mouth – available as lozenges, spray and chewing gum

- Reduces mouth dryness
- With protective lysozyme enzyme
- Maintains the oral mucosa
- Plaque-reducing and remineralizing



Article description	Content	REF
Aquamed Lozenges, 26 pcs.	60 g	630 164
Aquamed display (see page 91)	10 x 60 g	635 207
Aquamed Spray	30 ml	630 218
Aquamed Spray display (not shown)	12 x 30 ml	635 218
Aquamed combi-display	6 x lozenges, 6 x spray	635 222
Aquamed Dry Mouth Gum	30 dragées	630 223
Aquamed Dry Mouth Gum display (not shown)	12 x 30 dragées	635 230

## Xylitol Chewing Gum

### Dental care chewing gum

- Sweetened with 100% xylitol
- Free of aspartame, sorbitol, lactose and gluten
- Helps against bad breath
- Tooth decay preventive, plaque inhibiting and remineralizing
- Promotional HV display made of acrylic (see page 90) available on request

#### Reclosable tube with 30 gums / 30 g

Article description	Content	REF
Spearmint	30 dragées	630 079
Peppermint	30 dragées	630 080
Cinnamon	30 dragées	630 081
Fresh Fruit	30 dragées	630 082
Cranberry	30 dragées	630 090
Green Tea	30 dragées	630 091
Display, assorted (see page 90)	6 x 12 tubes	635 092

#### Dispenser box with 200 packs of 2 dragées each

Article description	Content	REF
Dispenser box chewing gums, assorted	200 pcs.	635 069

#### Big Pack with 200 dragées

Article description	Content	REF
Spearmint	200 pcs.	630 300
Fresh Fruit	200 pcs.	630 301



For more information and list of ingredients, see page 88

## Xylitol Chewing Gum for Kids

### Dental care chewing gum especially for children

- Sweetened with 100% xylitol
- Free of aspartame, sorbitol, lactose and gluten
- Child friendly design and taste
- Tooth decay preventive, plaque inhibiting and remineralizing

#### Reclosable tube with 30 gums / 30 g

Article description	Content	REF
Apple	30 dragées	630 192
Strawberry	30 dragées	630 193
Display Apple	12 tubes à 30 dragées	635 203
Display Strawberry	12 tubes à 30 dragées	635 206



For more information and list of ingredients, see page 88

## Xylitol Drops

### Sweetened with 100% natural Xylitol – sugar free

- Remineralizing
- Stimulates saliva production (ideal in xerostomia)
- Free of aspartame, sorbitol, lactose and gluten
- Cool and refreshing taste

Article description	Content	REF
Xylitol Drops Melon	60 g / 26 pcs.	630 170
Xylitol Drops Cherry	60 g / 26 pcs.	630 171
Xylitol Drops Mint	60 g / 26 pcs.	630 172

#### Dispenser box with 100 drops

Article description	Content	REF
Dispenser box, assorted	100 Drops	635 183





## Carebrush® white

### Toothbrush with „whitening effect“

- Brush head with special rubber lamellas cleans thoroughly, while also having a natural tooth whitening effect
- Spiral-shaped bristles at the front of the brush head optimize access to difficult-to-reach areas
- Criss-cross bristles support thorough cleaning of interdental spaces
- Anatomic „anti-slip“ handle

Article description	REF
Carebrush white, green	630 190
Carebrush white, pink	630 191
Carebrush white display, 8 pcs. each (page 92)	635 205



## Carebrush® supersoft

### Toothbrush with silky-soft micro bristles

- Silky-soft bristles for hypersensitive teeth necks and irritated gums (e.g. in periodontitis) and for dental care following prophylaxis treatments
- Gentle and thorough cleaning with low enamel abrasion
- Tongue scraper at back of the brush head
- Anti-slip handle

Article description	REF
Carebrush supersoft	630 195



## Carebrush® ortho

### Toothbrush with v-shaped bristle system for the cleaning of fixed braces

- For the cleaning of brackets and other orthodontic works
- V-shaped bristle field for an effective cleaning of brackets
- Soft inner bristles and harder outer bristles
- Long and narrow neck to simplify access to hard-to-reach areas

Article description	REF
Carebrush ortho	630 196



Weight: 60 g

## Prosonic micro 2

### Sonic toothbrush for being out and about

- 30.000 micro vibrations per minute
- Tongue scraper at back of brush head
- Replaceable battery (AAA) included
- Replacement brush-set includes 2 brush heads + 4 color-coded rings

Article description	REF
Prosonic micro 2, hand piece with brush head and battery	630 182
Prosonic micro 2, replacement set with 2 brush heads	630 183
Prosonic micro 2, Display with 24 toothbrushes and 6 replacement sets (page 92)	635 200



## Happy Morning®

### Disposable toothbrush

- Ideal for brushing teeth in the dental practice before treatment, on short trips, etc.
- Hygienically and separately packed



Article description	Content	REF
Happy Morning, impregnated with toothpaste	100 pcs.	605 401
Happy Morning, without toothpaste	100 pcs.	605 403



2.5 cm



with toothpaste



without toothpaste

## Happy Morning® Xylitol

### Disposable toothbrush with xylitol

- Bristles are impregnated with xylitol toothpaste
- Fresh flavor
- Short head design (2.5 cm)
- Hygienically and separately packed
- Ideal when traveling, in between meals and as toothbrush for guests
- Xylitol has an anti-cariogenous effect, decreases plaque- and acid-forming bacteria

Article description	Content	REF
Happy Morning Xylitol	50 pcs.	605 496

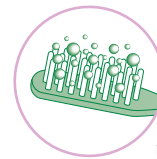

After meals



In the office



When travelling



Before a date



## Happy Morning® Travel Kit

### Dental care travel kit companion

- Toothbrush and 3 g tube with fresh mint toothpaste
- Toothbrush and tube hygienically blister-packed as set
- Toothbrushes in five colors, assorted, 5 x 10 pcs.

Article description	Content	REF
Happy Morning Travel Kit	5 x 10 pcs.	605 410



## Happy Morning® De Luxe

### Toothbrush with even bristle field

- Rounded bristles and angled handle
- Bristle size medium, separately packed

Article description	Content	REF
Happy Morning De Luxe	50 pcs.	605 443







## Mirawhite® shine

### Effective tooth whitening even in sensitive teeth

- Pen for hygienic application
- Tooth whitening with active-oxygen (Ardox-X® Technology), free of peroxide
- Gentle on enamel and gingiva
- Does not soften fillings
- Tooth whitening by up to five shades
- Period application 7 – 14 days, twice a day

Article description	Content	REF
Mirawhite shine	1.8 ml	630 194
Mirawhite shine, display	6 pack.	635 212



#### Dosing cap

For easy-to-measure doses of the mouth rinsing solution



## paroguard®

### Mouth rinsing solution

- Remineralizing due to fluoride (250 ppm)
- Ideal for patients with limited oral hygiene
- Astringent due to hamamelis
- Anti-cariogenous due to Xylitol
- Alcohol-free

Article description	Content	REF
paroguard	200 ml	630 087

### Size with advantage 5 liters

- Optionally available with dosing pump (1 push = 10 ml)

Article description	Content	REF
paroguard (without pump)	5000 ml	630 127
Pump separately		630 138



## mirafluor® chx

### Mouth rinsing solution with chx 0.06 %

- For daily use, incl. dosing cap
- Remineralizing due to fluoride (250 ppm)
- Astringent due to hamamelis
- Anti-cariogenous due to xylitol
- Alcohol-free
- Support of daily mouth care due to chlorhexidine gluconate (0.06 %)

Article description	Content	REF
mirafluor chx 0,06 %	100 ml	630 085
mirafluor chx 0,06 %	500 ml	630 086

## Mirawhite® gelée

### Intensive cleaning for shiny white teeth

- Immediate illuminating effect
- Restores natural tooth whiteness
- Innovative multiple-effectiveness
- Xylitol and sodium fluoride (fluoride 1,450 ppm) prevent tooth decay

Article description	Content	REF
Mirawhite gelée	100 ml	630 123
Mirawhite gelée, display	8 pack.	635 097_GB



## mirasensitive hap+®

### Intensive care for the preservation of sensitive teeth

- Sealing of open tubules
- 30 % hydroxyapatite builds up biomimetic enamel
- Potassium ions calm the tooth nerve
- Daily treatment to protect teeth from painful stimuli
- Contains fluoride and Xylitol to prevent tooth decay and tooth neck decay
- Mild and fresh taste
- RDA-value: 30
- Sodium fluoride (fluoride 1,450 ppm)

Article description	Content	REF
mirasensitive hap+	50 ml	630 169
mirasensitive hap+, display	8 pack.	635 191



## Mirafluor® C

### High-quality amino fluoride toothpaste

- RDA value 17
- Fine abrasive silica particles
- Mild mint flavor
- Amino fluoride (fluoride 1,250 ppm)

Article description	Content	REF
Mirafluor C	100 ml	630 083
Mirafluor C, display	8 pack.	635 195GB





Safe Implant



## Miraclin Implant

### Special toothpaste for dental implants

- The active oxygen technology maintains the teeth's natural whiteness
- Avoids discoloration between natural teeth and implants
- Ingredient combination e.g. lactoferrin enzyme supports an all-round protection of teeth, gingival pockets and implants
- Sodium fluoride (fluoride 200 ppm) prevent decay

Article description	Content	REF
Miraclin Implant	100 ml	630 165



## Mirafloss® Implant chx

### Floss fibers from the roll

- 50 floss fibers (15 cm each), rolled up in a handy dispenser
- Stiff ends facilitate threading
- Fleecy center part saturated with 0.2 % chx solution
- Ideal for the cleaning of implants and bridges
- Available in two thicknesses: fine (ø 1.8 mm) and medium (ø 2.2 mm)

Article description	REF
Fine (pink)	630 134
Medium (turquoise)	630 135



## Mirafloss® Big

### Wall-mountable dispensing box

- Ideal for professional use in practice
- One-handed operation using sharp metal edge
- Refillable

Article description	Content	REF
Mirafloss Big (white, waxed / black, waxed, mint)	2 x 200 m	605 735
Refills: black, waxed, mint	200 m	605 737
Refills: white, waxed	200 m	605 736
Refills: white, unwaxed	200 m	605 738



## Mirafloss®

### Dental floss/tape

- For specially thorough cleaning of interdental spaces
- Extremely tear-proof, does not fray
- Tape: not waxed, but consisting of PTFE, glides perfectly through even the narrowest interdental spaces

Article description	Content	REF
Tape	20 m	630 022
chx-Tape	20 m	630 078
Tape unwaxed	20 m	630 077

## SOS Dentobox

### Tooth rescue box after tooth accidents

- Special nutrient solution prolongs the chances to replant avulsed teeth and fragments for up to 48 hours
- Cells of the desmodontium remain intact until replantation
- Safe and verifiably best storage for preservation of one's tooth

Article description	Content	REF
SOS Dentobox		631 040
SOS Dentobox Display (page 95)	6 pcs.	635 115



## Zahnpick®

### Convenient combination of dental floss and toothpick

- 30 pcs.: handy resealable box, 100 pcs.: separately blister-packed

Article description	Content	REF
Zahnpick, Box	30 pcs.	630 039
Zahnpick, separately blister-packed	100 pcs.	605 637



Resealable box

## I-Prox® L

### Interdental brush in pocket size

- Lengthened L-shaped handle and 100° angle facilitate handling
- Hygienic protective cap
- Ideal on the go
- Six sizes from xx-fine – large
- Color-coded

Article description	Content	REF
I-Prox L, pink xx-fine	6 pcs.	630 210
I-Prox L, yellow x-fine	6 pcs.	630 211
I-Prox L, white fine	6 pcs.	630 212
I-Prox L, green medium	6 pcs.	630 213
I-Prox L, orange conical	6 pcs.	630 214
I-Prox L, bordeaux large	6 pcs.	630 215
I-Prox L, assorted	6 pcs.	630 216

Design	Ø Coated wire	Cleaning cylinder
xx-fine 	Ø 0.4 mm 	Ø 1.8 mm
x-fine 	Ø 0.5 mm 	Ø 2.0 mm
fine 	Ø 0.6 mm 	Ø 2.5 mm
medium 	Ø 0.7 mm 	Ø 3.5 mm
conical 	Ø 0.8 mm 	Ø 2.5 - 5.0 mm
large 	Ø 0.8 mm 	Ø 5.0 mm







## Pic-Brush® Set

### Interdental brush holder with one brush

- Connector system with conical neck for a safe fit
- Ergonomically shaped handle with 120° angle
- Flexible high-quality brushes, coated special wire, ultra-fine bristles
- Protection against injuries due to elaborate loop technique of wire end
- Holder end with storage compartment and clip-on function
- Also for cleaning of brackets, bridges and dentures

Article description	Color	REF
Holder with 1 brush	blue transparent	631 002
Holder with 1 brush	pink transparent	631 003
Holder with 1 brush	yellow	605 630
Holder with 1 brush	dark blue	630 001
Click-In Display with 9 pcs. (page 93)	assorted	635 167

## Pic-Brush® Intro Kit

### Interdental brush holder with four brushes in four thicknesses

Article description	Color	REF
Holder with 4 brushes	blue transparent	630 005
Holder with 4 brushes	pink transparent	630 006
Holder with 4 brushes	yellow	605 728
Holder with 4 brushes	dark blue	630 004

### Design

<b>pink</b> xx-fine		ø 0.45 mm		ø 1.6 mm
<b>yellow</b> x-fine		ø 0.5 mm		ø 1.8 mm
<b>white</b> fine		ø 0.6 mm		ø 2.0 mm
<b>green</b> medium		ø 0.8 mm		ø 2.2 mm
<b>blue</b> large		ø 0.8 mm		ø 3.0 mm
<b>bordeaux</b> x-large		ø 0.8 mm		ø 6.5 mm
<b>orange</b> conical		ø 0.5 mm		ø 2.5 - 5.0 mm

## Pic-Brush® Replacement Brushes

### In practical hygienic storage box



Color	6 pcs. REF	12 pcs. REF	25 pcs. REF
Pink	630 013	605 748	607 060
Yellow	631 014	605 713	607 061
White	631 015	605 722	607 062
Green	631 016	605 631	607 063
Blue	631 017	605 632	607 064
Bordeaux	630 050	605 789	607 065
Orange	631 018	605 711	607 066
Assorted		605 633	

## I-Prox® P

### Pointed brush for precise use

- Efficient cleaning of gingival border and gingival pockets with tapered bristle tuft
- Ideal for the cleaning of orthodontic appliances, implants and interdental spaces
- Optimal application of preparations
- Finger-grip handle (14 cm) with two click-on angles (60° and 120°)
- Holder end with storage compartment for brushes



Gingival pocket

Implants

Brackets

Article description	REF
Holder blue transparent incl. 4 tips	630 032
Holder pink transparent incl. 4 tips	630 033
Replacement brushes, 4 pcs.	630 034
Click-in Display with 9 pcs., assorted (page. 93)	635 168

### Switch-function

allows for two angles for various applications

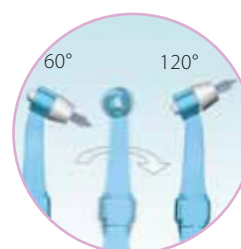
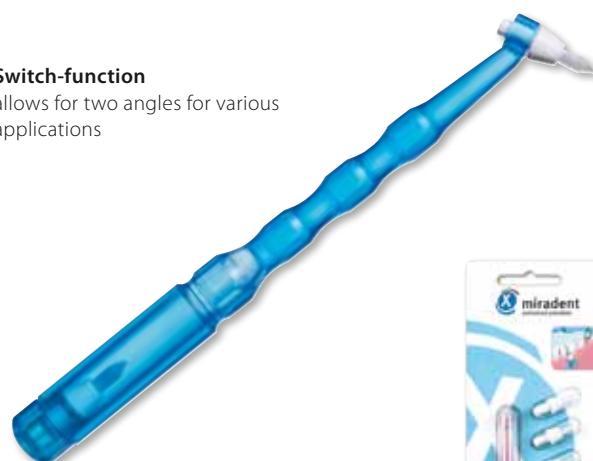

## I-Prox® Care Set

### Interdental care set

- For efficient cleaning of sulcus, interdental spaces and bridges
- Finger-grip handle allows for safe and precise use
- Holder end of sulcus brush with storage compartment for replacement brushes
- Anti-fog coated mouth mirror for immediate self control
- I-Prox C for persistent adherences, double-ended

#### Set includes:

miradent mouth mirror, I-Prox C (double-ended toothscaler/cleaner), I-Prox P Sulcus brush

Article description	REF
Set of 3, blue transparent	630 160
Click-In Display with 9 pcs. (page 93)	635 171



## miradent® Mouth Mirror

### Disposable plastic anti-fog mouth mirror

- Flat angulated mirror head reaches all regions in the mouth
- Novel anti-fog coating
- Ergonomic finger form handle
- For domestic tooth control
- Diameter 23 mm / no. 5

Article description	REF
Blue transparent	630 065

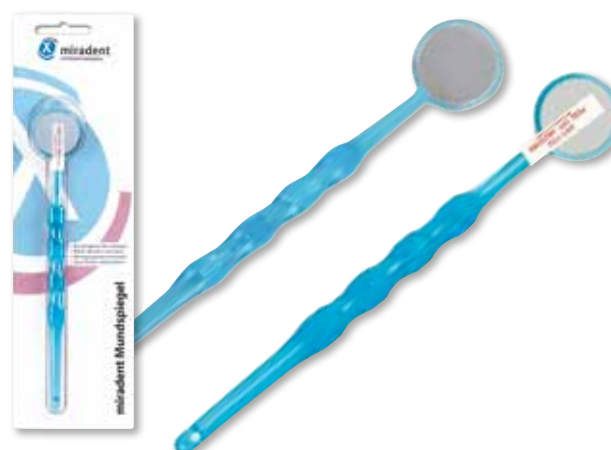

For mouth mirrors in practical economy pack (50 pieces), see page 36.



## Mira-2-Ton® Solution

### Plaque test

- Chewable tablet or solution
- Older plaque is revealed in blue, newer plaque in pink
- Proven in the dental practice for years
- Patient-friendly, motivating
- Erythrosine- and gluten-free
- Discolorations can be removed by brushing teeth
- Easy to have – one tablet sufficient for 2 applications

Article description	Content	REF
Mira-2-Ton solution	60 ml	605 655
Mira-2-Ton solution	10 ml	605 659
Mira-2-Ton solution, display	12 x 10 ml	605 660

## Mira-2-Ton® Tablets

Article description	Content	REF
Mira-2-Ton Tablets	6 pcs.	630 027
Mira-2-Ton Tablets	5 x 10 pcs.	605 765
Mira-2-Ton Tablets	250 pcs.	605 768
Mouth Mirror, blue transparent (ø 23 mm) separately		630 065
Click-in display (page 95)	16 pack.	635 027

## Plaque Check

- Contains three plaque test tablets and one mouth mirror (with anti-fog coating) for self-control

Article description	REF
Plaque Check with blue mirror	630 044
Click-in display with 9 pack., assorted (page 93)	635 138

## halitosis spray

### Oral care spray for immediate fresh breath

- Eliminates mouth odor (halitosis)
- Dental care properties due to added Xylitol (10%)
- Alcohol-free



Article description	Content	REF
halitosis spray	15 ml	630 168
halitosis spray display (page 95)	12 sprays	AK-1203GB



## Tong-Clin® De Luxe

### Tongue cleaner

- Dual function in one instrument:
  - Bristle field with short, rounded bristles lifts off tongue coatings
  - Tongue scraper removes the loosened coatings subsequently
- Angled, flat arched top reduces gag reflex
- Handy finger-grip handle with protective cap

Article description	Content	REF
Blue transparent		630 029
Pink transparent		630 030
Blue		605 778
Click-In Display, assorted (page 93)	9 pack.	635 170



## Tong-Clin® Gel

### Tongue cleaning gel with a gentle and nurturing cleaning effect

- Removes tongue coatings gently
- Nurtures with camomile, sage and calendula
- Long-lasting feeling of freshness
- Alcohol-free

Article description	Content	REF
Tong-Clin Gel	50 ml	630 059
Tong-Clin Set	Tong-Clin + 50 ml Gel	630 060
TC Set display (page 92)	12 pack.	635 018
Tong-Clin Fresh	Tong-Clin + 15 ml Gel	630 179
TC Fresh display (page 92)	14 pack.	635 198



## Protho Brush® De Luxe

### Prosthesis brush

- With two brush heads: large brush field for cleansing of outer prosthesis surfaces and smaller brush field for the hard-to-reach inner sides
- Ergonomically shaped finger form-grip handle

Article description	Content	REF
Blue transparent		630 024
Pink transparent		630 025
Dark blue		605 413
Click-In display, assorted (page 93)	9 pack.	635 169



## Protho Box

### Waterproof, lockable prosthesis box

- For storage and cleaning of prosthesis
- Waterproof due to special locking
- Holds 2 prostheses and approx. 80 ml of liquid
- Also suitable for storage of removable braces
- Box contains double-sided cleaning brush, white bristles for basic surfaces, black bristles for prostheses indentations
- Brush compartment also for cleaning tablets
- With mirror in the lid

Article description	REF
Box incl. brush	605 900
Brush separately	605 901



Dimensions (W x H x D):  
11.5 x 4.5 x 8.5 cm





## Infant-O-Brush®

### Learner's toothbrush integrated in a teething ring

- Teaches regular dental care in a playful way
- Teething ring with extra soft bristle field
- Nubs enhance dentition
- Oval shape eliminates risk of swallowing and injury
- For infants from 3 months of age

Article description	REF
Red	630 026
Yellow	605 617



## miradent® Hourglass

### Child-appropriate hourglass as timer for tooth brushing

- Ideal for observing the recommended minimum brushing time
- Running time: 2 minutes
- With suction cup, attachable to any smooth surface

Article description	REF
miradent Hourglass	630 068



## Dento Box® I

### Solid transport and storage box

- For prosthesis, orthodontic works, etc.
- Impact-proof, safe snap lock and small ventilation holes
- With trendy hang cord

Article description	REF
Dento Box I, white	630 162
Dento Box I, blue	630 161
Dento Box I, pink	630 163

For Dento Box without hang cord see page 53



## Xylitol Chewing Gum – Ingredients

### Product description see page 77

#### Spearmint, Peppermint, Cinnamon - Ingredients:

Sweetener: xylite, gum base, flavor, humectant: glycerin, thickening agent: gum arabic, emulsifier: soy lecithin, coloring agent: titanium dioxide, coating agent: carnauba wax.

#### Fresh Fruit, Cranberry - Ingredients:

Sweetener: xylite, gum base, flavor, humectant: glycerin, thickening agent: gum arabic, acidity regulator: malic acid, emulsifier: soy lecithin, coloring agent: titanium dioxide, coating agent: carnauba wax.

#### Green Tea - Ingredients:

Sweetener: xylite, gum base, flavor, humectant: glycerin, thickening agent: gum arabic, leaf extract (green tea), emulsifier: soy lecithin, coloring agent: titanium dioxide, coating agent: carnauba wax.

#### Xylitol Chewing Gum for Kids - Ingredients:

Sweetener: xylite, chewing base, aroma, acidity regulator: malic acid, thickening agent: gum arabic, humectant: glycerine, colorant: titanium dioxide, emulsifier: soy lecithin, coating: carnauba wax.

**Hint:** Chewing Gum with sweetener. Excessive consumption may produce laxative effects.

## Plaque Agent®

### Plaque disclosing liquid

- Existing plaque is revealed in blue
- Pleasant "bubble gum" flavor
- Ready-to-use, motivating, child-friendly
- Coloring can be easily removed by brushing teeth
- Application: 1–2 x per day 10 ml, rinse for approx. 30 sec. prior to toothbrushing
- Erythrosine-free, alcohol-free
- Incl. dosing cap

Article description	Content	REF
Plaque Agent	500 ml	631 096
Plaque Agent display (page 95)	5 bottles	635 176



## Funny Animals

### Hygienic toothbrush holder

- Easy snapping in place and removal of toothbrush
- Patented snap lock
- With two suction cups, attachable to any smooth surface
- Ventilation slots ensure an ideal air exchange
- Fitting for any off-the-shelf toothbrush
- For children from the age of three

Article description	REF
Funny Cow	630 099
Funny Giraffe	630 220
Funny Panda	630 222
Funny Lion	630 102
Funny Elephant	630 100
Funny Hippo	630 221



**Suction cups**  
attachable to any  
smooth surface

## Kid's Brush

### Children's Toothbrush

- Small head with oval bristle field
- Plane tuft field with soft rounded nylon bristles
- "Upper body" is hinged and protects the bristle field
- Air circulation by opening in the protective cap
- Brush handle also serves as practical stand
- For children from the age of four

Article description	REF
Duck (2)	630 046
Parrot (1)	630 047
Bear (4)	630 048
Dog (3)	630 049
Set, 4 pcs. assorted	605 820







W x H x D: 11 x 16.5 x 8.5 cm

### Xylitol Chewing Gum Dental care chewing gum

For product information see page 77

Article description	Content	REF
Dispenser box, assorted	200 pcs. à 2 dragées	635 069
Display, assorted	6 x 12 tubes à 30 pcs.	635 208



W x H x D: 24.2 x 37.4 x 13.4 cm



W x H x D: 11 x 16.5 x 8.5 cm

### Xylitol Drops – Tooth friendly drops Sweets with 100 % natural Xylitol – sugar free

For product information see page 77

Article description	Content	REF
Dispenser box, assorted	100 drops	635 183
Display, Melon	12 bags à 60 g / 26 pcs.	635 185
Display, Cherry	12 bags à 60 g / 26 pcs.	635 186
Display, Mint	12 bags à 60 g / 26 pcs.	635 187
Display, assorted 3 x 4	12 bags à 60 g / 26 pcs.	635 182



W x H x D: 12 x 29.7 x 19 cm

## Xylitol Chewing Gum Dental care chewing gum

For product information see page 77



W x H x D: 13 x 19 x 10 cm

Article description	Content	REF
Display Spearmint	12 tubes à 30 pcs. / 30 g	635 052
Display Peppermint	12 tubes à 30 pcs. / 30 g	635 053
Display Cinnamon	12 tubes à 30 pcs. / 30 g	635 054
Display Fresh Fruit	12 tubes à 30 pcs. / 30 g	635 055
Display Cranberry	12 tubes à 30 pcs. / 30 g	635 056
Display Green Tea	12 tubes à 30 pcs. / 30 g	635 057
Display Kids Apple	12 tubes à 30 pcs. / 30 g	635 203
Display Kids Strawberry	12 tubes à 30 pcs. / 30 g	635 206

## Xylitol Chewing Gum Dental care chewing gum especially for children

For product information see page 77



W x H x D: 13 x 19 x 10 cm



W x H x D: 20.5 x 26.5 x 25.4 cm

## Aquamed® Stimulate salivation – available as lozenges and spray

For product information see page 76

Article description	Content	REF
Aquamed display	10 x 60 g	635 207
Aquamed Spray display (not shown)	12 x 30 ml	635 218
Aquamed combi-display (page 76)	6 x lozenges, 6 x spray	635 222



W x H x D: 13.3 x 36.5 x 26 cm

## Xylitol Powder A 100 % natural and healthy sugar substitute

For product information see page 76

Article description	Content	REF
Xylitol Powder display	5 packs à 350 g	635 080





W x H x D: 26 x 37 x 17 cm

W x H x D: 21 x 33.5 x 14.5 cm

**Tong-Clin® Fresh**  
**Tong-Clin® Set**  
 Tongue cleaning gel with a gentle and  
 nurturing cleaning effect

For product information see page 87

Article description	Content	REF
Tong-Clin Fresh display	14 x 15 ml gel + tongue cleaner	635 198
Tong-Clin Set display	12 x 50 ml gel + tongue cleaner	635 018



W x H x D: 26 x 37 x 17 cm

**Carebrush® white**  
 Toothbrush with "whitening effect"

For product information see page 78

Article description	Content	REF
Carebrush white display	8 pcs. each	635 205



W x H x D: 20 x 65.4 x 17.7 cm

**Prosonic micro 2**  
 Sonic toothbrush with tongue scraper

For product information see page 78

Article description	Content	REF
HV-display Prosonic	24 toothbrushes and 6 replacement sets à 2 pcs.	635 200



W x H x D: 14.5 x 32 x 12.5 cm

**Happy Morning® Travel Kit**  
 Dental care travel kit companion

For product information see page 79

Article description	Content	REF
Happy Morning Travel Kit	5 x 10 pcs.	605 410

**1 Pic-Brush® Set**  
Interdental brush holder with one brush

For product information see page 84

Click-In tray	Content	REF
(1) Pic-Brush Set	9 pcs, assorted	635 167

**2 Plaque Check**  
Plaque test tablets + mouth mirror (anti-fog)

For product information see page 86

Click-In tray	Content	REF
(2) Plaque Check	9 pcs., blue transp.	635 138

**3 I-Prox® P**  
Pointed brush for precise use

For product information see page 85

Click-In tray	Content	REF
(3) I-Prox P	9 pcs., assorted	635 168

**4 Tong-Clin® De Luxe**  
Tongue cleaner

For product information see page 87

Click-In tray	Content	REF
(4) Tong-Clin De Luxe	9 pcs., assorted	635 170

**5 I-Prox® Care Set**  
Interdental care set

For product information see page 85

Click-In tray	Content	REF
(5) I-Prox Care Set	9 pcs.	635 171

**6 Protho Brush® De Luxe**  
Prosthesis brush

For product information see page 87

Click-In tray	Content	REF
(6) Protho Brush De Luxe	9 pcs., assorted	635 169



W x H x D: 9,5 x 31 x 22 cm



W x H x D: 19,5 x 24,5 x 14 cm

**mirasensitive hap<sup>+</sup>**  
Intensive care for the preservation of sensitive teeth

For product information see page 81

Article description	Content	REF
mirasensitive hap <sup>+</sup> display	8 pack. à 50 ml	635 191



W x H x D: 22,5 x 27,5 x 26,8 cm

**Mirafleur® C**  
High-quality amino fluoride toothpaste

For product information see page 81

Article description	Content	REF
Mirafleur C display	8 pack. à 100 ml	635 195GB



W x H x D: 17,5 x 33 x 21,7 cm

**Mirawhite® gelée**  
Intensive cleaning for shiny white teeth

For product information see page 81

Article description	Content	REF
Mirawhite gelée display	8 pack. à 100 ml	635 097_GB



W x H x D: 7,4 x 28 x 23,2 cm

**Mirawhite® shine**  
Effective tooth whitening even in sensitive teeth

For product information see page 80

Article description	Content	REF
Mirawhite shine display	6 pack. à 1,8 ml	635 212





W x H x D: 9,4 x 35,0 x 25,4 cm

**Plaque Agent®**  
Plaque disclosing liquid

For product information see page 89

Article description	Content	REF
Plaque Agent display	5 bottles à 500 ml	635 176



W x H x D: 26 x 37 x 17 cm

**Mira-2-Ton®**  
Plaque test for home use

For product information see page 86

Article description	Content	REF
Mira-2-Ton display	16 blisters à 6 pcs.	635 184



W x H x D: 18 x 22,5 x 16,6 cm

**halitosis spray**  
Oral care spray for immediate fresh breath

For product information see page 86

Article description	Content	REF
halitosis spray display	12 sprays à 15 ml	AK-1203GB



W x H x D: 16,5 x 38 x 16 cm

**SOS Dentobox**  
Tooth rescue box after tooth accidents

For product information see page 78

Article description	Content	REF
SOS Dentobox display	6 pack.	635 115





## Stand-up display IV The miradent bestsellers at a glance

For product information see pages 82 to 89

Article description	Content	REF
Display equipped with:		
Mira-2-Ton tablets	5 blisters à 6 pcs.	
Pic-Brush Set, blue transparent	3 blisters	
Pic-Brush Set, pink transparent	2 blisters	
Pic-Brush replacement brushes yellow, green, orange	3 blisters each à 6 pcs.	
I-Prox P replacement brushes	3 blisters each à 4 pcs.	
I-Prox Care Set	5 blisters	
I-Prox L, assorted	4 blisters à 6 pcs.	
Zahnpick	4 blisters à 30 pcs.	
Tong-Clin Set	2 packages	
Protho Brush De Luxe blue and pink transparent	2 blisters each	
Tong-Clin De Luxe blue and pink transparent	2 blisters each	635 133
Protho Box	2 packages	
Mirafloss Implant chx, fine	2 blisters	
Mirafloss Implant chx, medium	1 blister	
Kid's Brush	2 blisters each	
miradent Dentobox white, blue, pink	1 piece each	
Funny Animals cow, giraffe, lion	2 blisters each	
Infant-O-Brush, red	4 blisters	
miradent Hourglass	4 blisters	
miradent newspapaers	500 pcs.	
miradent flyer for end-consumer	100 pcs.	
miradent product information	1 brochure	

Similar to photo  
(equipping may vary)

## Dipol®

### Proven wetting agent for all phosphate and plaster investment materials

- For an exact and clean pour
- Wax-degreasing, reduces the surface tension of wax
- Dipol builds a molecular bridge between water-repellent wax and investment compounds which can flow bubble-free and accurately adapting to the wax. Clean, smooth surfaces
- It contains no delaying chemicals which can lead to rough surfaces
- Dipol is also suited excellently as wetting agent on impressions of silicone, polyether, etc. for a trouble-free outpouring with plaster
- Free from formaldehyde and alcohol
- Without fuel gas, pumping atomizer with micro fine spray fog

Article description	Content	REF
Set with 1 l bottle + 1 pump bottle (empty)	1000 ml	605 044
Pump bottle, filled	100 ml	605 043
Pump bottle, empty		605 045



## Mirapor®

### Isolates plaster from plaster

- Without any film build-up, not silicon binding
- Precise, very simple separation
- Plaster parts release without aid
- No discoloration of the models
- Surfaces are sealed against dirt and water
- Plaster surfaces can be polished brilliantly with a brush or a cloth
- Without fuel gas, formaldehyde-free

Article description	Content	REF
Set with 1 l bottle + 1 pump bottle (empty)	1000 ml	605 113
Pump bottle, filled	100 ml	605 119
Pump bottle, empty		605 114



## Mirawet®

### Disinfecting mixing liquid for all kinds of pumice powder

- Keeps the polishing compound creamy all day long
- Excellent bactericidal, fungicidal and tuberculocidal effect
- Virus-deactivating, effective against HBV and HIV viruses
- Skin-protecting, pH-neutral
- Biologically degradable and free from formaldehyde

Article description	Content	REF
Mirawet	5 l	554 105





## Alminax

### Aluminum wax

- For absolutely precise bite registration
- Stable wax sheets (3 mm thick)
- High percentage of aluminum keeps the sheets warm very well
- Extremely hard after cooling off
- Just heat up with warm water

Article description	Content	REF
Alminax	250 g	101 301



## Alminax Rite-Bite

### Preformed bite indexes from special aluminum wax

- Very stable due to a reinforcing aluminum section
- Precise bite registration without interfering with the tongue
- Warmed up quickly in 50 °C hot water, Rite-Bite is individually mouldable, cooled off extremely hard and shape-retaining
- 2.5 mm thick bite index for optimal bite registration and precise working
- Also ideal for face bow registration

Article description	REF
Alminax Rite-Bite, box of 24 reinforced and 6 plain indexes	101 302



## Corund SC

### Long-lasting finishing and grinding paper

- In the grain size 80 (very coarse) - 220 (fine)
- The pointed grain is preserved for a long time
- 15 mm wide

Article description	Length	Grain	REF
Corund SC No. 80	25 m	80	605 016
Corund SC No. 100	30 m	100	605 017
Corund SC No. 120	30 m	120	605 018
Corund SC No. 150	30 m	150	605 019
Corund SC No. 180	50 m	180	605 020
Corund SC No. 220	50 m	220	605 021

## Non-Stick®

### Special silicone spray

- Isolation, protection and care spray
- Essential to ensure long service life of articulators
- Condyles, balls and all movable parts are gliding very easily
- For surface isolation against plaster of model holders (norm)
- Prevents sticking of plaster on trimmers, flasks and elastic layers, etc.
- Makes devices hinges smooth-running

Article description	Content	REF
Non-Stick	400 ml	554 206



## Occlu® Spray Plus

### High-quality green occlusion spray

- For marking of contact points by direct spraying onto the occlusion surface
- Micro powder coating for highest accuracy
- Plastic nozzle for extra fine spray mist
- Powder layer can be easily removed with water
- Economic in consumption

Article description	Content	REF
Spray can, green	75 ml	554 205
Spray can, green	50 ml	554 211



## Vernax® S / Vernax® G

### Insulating varnishes for stumps etc.

- Silver- and golden-colored
- Even film of approx. 10 µm
- Indissoluble against isolating means and evaporation
- Heat-proof during the deep drawing and by the use of diving wax
- Quick-drying

Article description	Content	REF
Vernax S (silver), bottle with brush	20 ml	605 065
Vernax G (gold), bottle with brush	20 ml	605 066



## Vernax® Thinner

- Clear liquid to thin Vernax 100, Vernax S., Vernax G as well as Vernax Antagon

Article description	Content	REF
Vernax thinner, bottle with brush	20 ml	605 068

## Vernax® 100

### Insulating varnish, 100% of fine silver for stumps etc.

- Absolutely steady film of 8 – 10 µm (1 layer)
- Can also be applied in several layers
- Indissoluble against all isolating agents and evaporation
- Heat-proof during the deep drawing and by the use of diving wax
- Quick-drying
- Can be cleanly removed with acetone
- Recommended for full ceramic inlays and crowns, etc. (e.g. Empress, Ivoclar)

Article description	Content	REF
Vernax 100, bottle with brush	20 ml	605 063



## Vernax® Colloidal Graphite

### Dark graphite in liquid form

- With integrated brush easy to apply
- Solder does not flow over the graphite limitation
- No lunker building within the joint
- Makes telescope and conical crowns move smoothly
- Diluteable with water

Article description	Content	REF
Vernax Colloidal Graphite, bottle with brush	20 ml	605 069



All Vernax products come with an integrated brush at the inside of the sealing cap.





## Mirapont®

A pale, highly precise special acrylat for stumps, hard plastic models and single teeth

- Very thin and slightly fluent material
- Both liquids (components A and B, relation 1:1) are mixed within 30 sec.
- Can be poured into silicone, alginate, reversible hydrocolloid and thermoplastic
- After 90 min. it can be sawed, milled and polished

Article description	REF
Mirapont 500 g Content: 250 g liquid A, 250 g liquid B, 2 dosage bottles A and B, 200 ml Agent Plus, 50 g Silifit, 5 measuring cups, 1 shaker with pouring spout, 2 big mixing spatulas, 5 small mixing spatulas, one-way gloves	203 010
Mirapont 1,000 g Content: 2 x 250 g liquid A, 2 x 250 g of liquid B, 2 dosage bottles A and B, 200 ml agent plus, 50 g silifit, 5 measuring cubs, 1 shaker with pouring spout, 2 big mixing spatulas, 5 small mixing spatulas, one-way gloves	203 011



## Mirapont® Agent Plus

- Isolates Mirapont against waxes
- Isolates polyether and polysulfide materials against Mirapont

Article description	Content	REF
Mirapont Agent Plus	200 ml	203 016

## Mirapont® Silifit

- Special block-out material, kneadable

Article description	Content	REF
Mirapont Silifit	250 g	203 015



## Praxipol PS II

Pressure polymerization vessel

- Approx. 6 l content
- For hot and cold polymerization
- Incl. inlet valve, pressure gauge and safety valve (GS-TÜV-approved)
- Nonstick layer inside to avoid corrosion

Article description	Length	REF
Praxipol PS II		401 450
Additional hose with coupling, 2 m	2 m	401 401

## Mirabol®

### Green flexible mixing bowls

- Easy to clean
- For alginate, plaster, etc.
- Flexible material of first-class quality
- Available in three sizes/heights

Article description	ø	Height	REF
No. 1 large	12 cm	9 cm	304 331
No. 2 x-large	13 cm	11 cm	304 332
No. 3 jumbo	17 cm	13 cm	304 333
Plaster Spatula RS			304 314



## Flex-O-Bol

### Classic, dark green alginate mixing bowl

- Easy to clean, flexible
- For alginate, plaster etc.
- Available in four sizes

Article description	ø	Height	REF
No. 1/4 small	8 cm	5,5 cm	304 320
No. 1/2 medium	10,5 cm	7,5 cm	304 321
No. 1 large	12 cm	9 cm	304 322
No. 2 x-large	14 cm	11 cm	304 323



## Algimix

### Alginate mixing device

- Reliable, solid stainless steel body, maintenance-free
- Minimal time exposure
- Electronically controlled, even stirring movement mixes powder and liquid to an absolutely homogeneous bubble-free alginate mass
- High-quality, durable mixing bowl made of flexible silicone
- Stirring speed adjustable in two steps

#### Technical data

Voltage:	230 V
Power consumption:	100 W
Fuse:	1.25 A
Size incl. bowl (W x H x D):	13,5 x 23 x 20 cm
Weight with (without) bowl:	3.7 kg (3.5 kg)

Article description	REF
Device with bowl and spatula	452 045
Bowl only	452 046
Spatula only	304 317



## Mirator® 2000E

### Electronically adjustable vibrator

- Continuously variable to up to 6,000 vibrations/min.
- Sturdy and powerful
- Worktop available separately upon request

#### Technical data

Worktop:	13 x 15 cm
Voltage:	230 V – 50/60 Hz
Power consumption:	max. 200 W
Safety fuse:	1 A
Weight:	3.5 kg

Article description	REF
Mirator 2000E	401 350



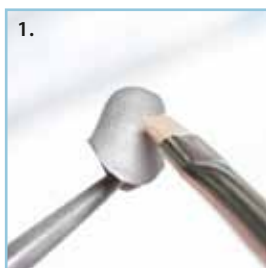

Application of Carat Biopaque Base Paste (first layer)



Application of Carat Biopaque Shade Paste (second layer)

## Carat® Base Paste

### Excellent bonding to metal and porcelain

- Wide CTE (Coefficient of Thermal Expansions)
- Range between 13.9-15.1 x 10<sup>-6</sup> K<sup>-1</sup>(25 - 600 °C)
- Compatible with 99% of all high-fusing precious and non-precious base alloys
- Ultra thin (0.15 mm) and even opaque layer with outstanding covering power
- Highly economic - exact dosage lasts for 150 - 200 crowns
- Easy-to-use and ready-to-use

Article description	Content	REF
Base Paste separately	2 ml	604 407

## Carat® Biopaque®

### Crystal powders range

Powder crystals give a unique surface roughness as well as natural light reflection. Depending on the tooth color light and dark powdering crystals are used. Crystals powder transparent is used to achieve the desired surface roughness, they give the ceramic a refraction of light very similar to natural teeth. Both can use the especially designed collecting bowl to avoid loss of excess particles.

Benefits of Carat Biopaque and Crystal system:

- Safe and easy handling
- Thin and even layer
- Economical use
- Easy individualization
- Natural light refraction
- Ready-to-use
- Excellent bonding
- Optimal appearance of any ceramic
- Useable for almost any alloy and porcelain



Firing schedule

Article description	Content	REF
Powdering crystal, dark	10 g	604 205
Powdering crystal, light	10 g	604 206
Powdering crystal, transparent	10 g	604 207

## Carat® Ecoline

### Dental ceramic system

Carat Ecoline is compatible with almost any high-fusing precious and non-precious base alloys and especially designed for Thermal CTE of 13.9 - 15.1 X 10<sup>-6</sup> K<sup>-1</sup> (25 - 600 °C). Carat Ecoline features excellent thermal stability and "forgives" little mistakes that may occur in technique or equipment.

The range contains all essential masses (sixteen detains in VITA colors, five enamels and one overglaze powder). It has become a synonymous for the reproduction of highest-quality dental ceramics system.

- Easy handling
- Time saving
- Excellent compatibility with Vita-Shades



Firing schedule

Article description	Content	REF
Carat Ecoline Dentin A2	55 g	604 531
Carat Ecoline Dentin A3	55 g	604 532

Further colors on request

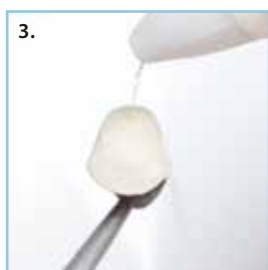

Application of Carat Biopaque powdering crystals



Metal frame after second firing prepared with Carat Biopaque Shade Paste and powdering crystals



First layer with Carat Ecoline Dentin Material

## Carat® Ecoline Enamel

### Enamel material

- Reliable physical characteristics
- Can be combined with the colors, shoulder materials and other accessoires of the Carat system

Article description	Content	REF
Carat Ecoline Enamel, extra light	55 g	604 549
Carat Ecoline Enamel, light	55 g	604 546
Carat Ecoline Enamel, medium	55 g	604 547
Carat Ecoline Enamel, dark	55 g	604 548

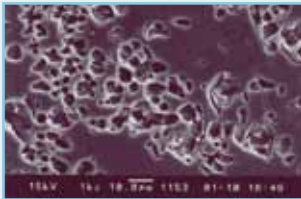

Ecoline Dentin porcelain

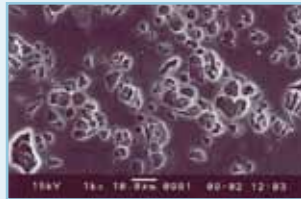

Ecoline Enamel porcelain

## Carat® Ecoline Overglaze

### Overglaze powder

- Achieves a natural glaze, particularly by permitting adjustment after the actual glaze firing

Article description	Content	REF
Carat Ecoline Overglaze	15 g	604 551

#### Properties of Carat Ecoline Dentin porcelain

Properties	Results
Firing temperatures	opaque: 975 °C dentine: 925 °C
Strength (ISO 6872)	70±10 MPa (range: 60 – 82 MPa)
Thermal expansion coefficient (500 °C)	12,5 ± 0,5 ppm/°C
Dilatometric softening point	642 °C
Glass transition temperature	513 °C
Hardness (Vickers)	570 kg/mm <sup>2</sup>
Microstructure	See REM photos
Leucite content (wt. %)	30 – 35 %
Leucite content	8 – 10 µm
Particle size distribution	Ecoline Dentin mean: 21.6 µm median: 19.4 µm
Bond strength (ISO 9693)	(Legacy) 26 MPa (Excel) 27 MPa (Biocclus 4) 30 MPa (Degudent SF) 39 MPa
Chemical solubility (ISO 9693)	17 µm/cm <sup>2</sup>

## Carat® Modeling Liquid

### Modeling fluid

- Fluid for all opaque powder, dentine, enamel and transparent materials, guaranteeing excellent modelling properties and stability

Article description	Content	REF
Carat Modeling Liquid UNF	100 ml	604 217



Crown totally covered with Carat Ecoline Dentin and Enamel Material



Application of the Carat Glaze material

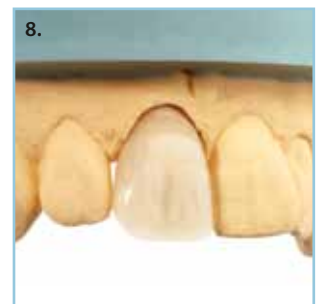

Finished crown after the glaze firing







## Balance® Articulator

### THE classical Non-Arcon articulator

- Precise, functional working device for complete and partial dentures as well as for crown and bridge works
- Worldwide the standard-Non-Arcon articulator
- Available in 2 construction heights: 95 mm, 105 mm (measurements without base plate)
- Joints and parts made of stainless steel
- Torsion-resistant and free access to the model
- Extendable by numerous accessories as for example facial curve, foundation scales, calotte
- Mounting plates optionally available
- The balance with 20°, 30° or 40° condyles is available with 0°, 10° or 15° incisal plate

#### Technical data:

Condylar inclination 25°  
 Incisal table 5°  
 Bennett angle 0° bis 25°  
 Intercondyle distance 100 mm

#### Scope of supply:

Articulator, incisal table,  
 incisal pin, 2 mounting plates,  
 rubber bands  
 allen key

Article description	REF
Balance 95	203 201
Balance 105	203 295



## Balance® Facebow

### One hand facebow with fast-lock

- For fast and precise cast transfer for the Balance / Balance De Luxe
- Easy handling as the joints can be fixed by hand
- Optimal adjustment to the Frankfurt Horizontal plane by a new type of horizontally and vertically adjustable Glabella support
- The transfer part with bite fork impression can immediately be transferred into our articulators (without facebow)
- An exact three-dimensional model assignment can be achieved in the articulator

#### Scope of supply:

Scissor bow and Glabella support  
 Transfer part and bite fork  
 Balance adapter set

Article description	REF
Balance Facebow 95	203 228
Balance Facebow 105	203 330



## Balance® De Luxe Articulator

THE reliable articulator with individually adjustable condyle orbit inclination

- Individually adjustable condyle orbit inclination
- For individual preparations in full dentures as well as for crown and bridge technique
- Available construction height: 105 mm (measurement without mounting plate)
- Joints and parts made of high-grade steel
- Torsion-resistant and free access to the model, also from behind
- Extendable by numerous accessories as for example facebow

### Technical data:

Condylar inclination -10° to + 70°  
 Incisal table 5°  
 Bennett angle 0° bis 25°  
 Intercondyle distance 100 mm

### Scope of supply:

Articulator, incisal table,  
 incisal pin, 2 mounting plates,  
 rubber bands  
 allen key

Article description	REF
Balance De Luxe 105	203 320



## Balance® Mounting Plates

Aluminum with screw thread

- Fits to Balance / Balance De Luxe, also for Atomic F and Combitec A

Article description	REF
Mounting Plates, 2 pcs.	203 204



## Koni-Cast

Conical cast rings

- Made of high quality stainless steel
- Bases also available in special silicone and a flexible multi base
- X1 small: dia. top 32 mm, bottom 30 mm, height 55 mm
- X3: dia top 50 mm, bottom 48 mm, height 55 mm
- X6: dia top 67 mm, bottom 65 mm, height 55 mm
- Bigger shapes on request

Article description	REF
Koni-Cast, X1	304 031
Koni-Cast, X3	304 033
Koni-Cast, X6	304 034



## Miracast

Model former

- With vertical retention marks inside
- Inexpensive, in three sizes

Article description	Size	REF
Miracast UK small	80 x 60 x 15 mm	203 066
Miracast UK medium	85 x 65 x 15 mm	203 067
Miracast OK small	75 x 60 x 15 mm	203 065
Miracast OK medium	80 x 61 x 15 mm	203 068
Miracast OK large, fits for upper and lower impressions	100 x 80 x 15 mm	203 069





Weight 300 g



## Bravo Marathon Portable III

### Powerful, portable micromotor

- Allows for working everywhere, ideal for home visits
- Infinitely variable motor with backward- and forward running (4,000 – 35,000 r/min)
- Lithium-ion accumulator for longer working times of up to 12 hours
- Recharging time approximately 5 hours
- Only for extraoral works
- Suitable for every standard hand and contra-angle piece with plane shaft without intra-spray and without light conductor
- Can be attached to the belt, space-saving

Article description	REF
Bravo Portable III with belt bag and recharger	452 130

Unit comes without HP or CA.

For standard hand pieces and contra-angles see page 111.

## Bravo Portable II

### Strong portable micro motor

- Allows working without wallsocket, ideal for home visits (weight 300 g)
- Infinitely variable motor with back- and forward-running (0–25,000 rpm)
- Rechargeable, long-lasting battery recharging time six hours, up to eight hours pure working time
- For extraoral works only
- Suitable for any standard hand and contra-angles piece with plane shaft (not included in delivery ) without intra-spray and without light conductor
- Can be attached to the belt, space-saving

Article description	REF
Bravo Portable II with belt bag and recharger	452 102



## Bravo TD III

### Collector-free AC motor (3-phase-motor)

- Small device for drilling, polishing, etc.
- Fits all conventional hand pieces and contra-angles
- Speed infinitely and precisely variable from 1,000–30,000 rpm
- Forward and reverse rotation, with optic indication
- Solid, low-maintenance plastic body
- For extraoral use only

#### Technical data

Supply voltage:	230 V
Motor capacity:	max. 40 W
Size (H x W x D):	80 x 205 x 153 mm
Weight: approx.:	2.5 kg

Article description	REF
Bravo TD III	452 106



Collector-free AC motor



Foot switch

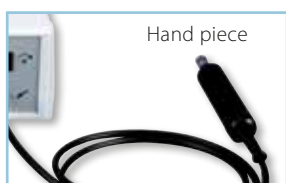

Hand piece

## Speed Labolight®

### Universal light polymerization device

- For all light-curing dental materials
- Nanometer spectrum 320 – 550 nm
- Optimized light mixture for a homogenous and safe curing
- Circular arrangement of eight rod-shaped lamps around a turntable (dia. 14 cm) and one halogen lamp
- Interval turntable for an evenly light impact and curing
- Adjustable from one second to 99 minutes, protection against overheating, polymerization temperature in the chamber does not exceed 40 °C
- Durable (approx. 1,000 hours), easy-to-exchange lamps
- Acoustic signal indicates end of polymerization
- Operating hours counter

#### Technical data

Supply voltage:	230 V, 50 Hz	<b>Size and weight</b>	(W x H x D): 25 x 29 x 24 cm
Power consumption:	225 W	Weight:	7 kg
Fuse:	1 x 2.5 A	Turntable: ø	14 cm
Lamps:	8 x 9 W T1 (white light) 4 x 9 W T8 (UV-A) 1 x 150 W (halogen)		

Article description	REF
Unit incl. 13 lamps	401 125

#### Separate single lamp

Article description	REF
T1 (white light) 9W / 71	901 002
T8 (UV-A) 9W / PLS-10	901 003
Halogen	901 004
Set (4 x T1 and T8, 1 x halogen each)	901 001



## Glas Bead Heater

### Device for heating up instruments

- Ideal to obtain anti-fog effect with mouth mirrors or instrument prior to treatment
- Not suitable for sterilization
- Special heating element warms glass beads up to 230 °C and keeps the temperature constant without heating the outer body of the device
- Removable chamber, easy cleaning
- Size (W x H x D): 140 x 130 x 190 mm, chamber ø 50 mm

Article description	REF
Glas Bead Heater incl. 200 g glas beads	452 303
Glass bead refill pack, 200 g	452 304



## Solderfix

### Soldering Aid

- Two ball bearing holding arms for an optimal positioning of the objects to be soldered
- The base plate is equipped with a fireproof ceramic fiber plate
- Measurements: 230 x 152 mm

Article description	REF
Solderfix	304 451







## Blue-Flame 1500

### Handy burner for dental practice and laboratory

- Easy, practical one-hand operation
- Reliable ignition
- Solid freestanding burner, 15 cm only
- Flame temperature infinitely variable from approx. 800 – 1,300 °C, max. burning time approx. 35 minutes
- Refillable with APT gas (not included in scope of delivery)
- Diverse fields of application in household use

Article description	REF
Blue-Flame 1500	401 006



## APT III Burner

### Convenient burner with one-hand operation

- Activation of ignition without having to put the instrument down
- Extra reliable ignition system
- Infinitely variable flame
- Transport securing
- Refillable with APT gas (not included in scope of delivery)

Article description	REF
APT III Burner	401 001



## Kisag Burner

### Gas burner for dental practice and laboratory

- Flame temperature infinitely variable from approx. 750 – 1,150 °C
- One filling for a burning time of 5–6 hours
- With the Swiss SVGW sign (equivalent to the German GS sign)
- Refill with Kisag gas only

Article description	REF
Kisag Burner incl. 400 ml Kisag gGas	401 005
Kisag Gas, 400 ml	605 140

## APT Gas

### Refill gas

- With various adapter tips to refill APT, Miratorch and Blue Flame burners, etc.
- Not suitable for Kisag Burner

Article description	Content	REF
APT Gas	200 ml	605 143

## Miratorch®

### Inexpensive dental burner for dentist and laboratory

- Small, handy burner (170 g)
- Easy adjustment and control of temperature and flame, infinitely variable
- Burning temperature 1.300 °C
- Burning time approx. 60 – 70 minutes
- Refillable with APT gas (not included in scope of delivery)

Article description	REF
Miratorch	401 010



## Speedo-Clean

### Quiet denture cleaning device

- Esthetic surface cleaning using rotating polishing needles in combination with a cleansing liquid – no material abrasion
- Integrated timer allows for individual cleaning times
- Additional magnet keeps the needles in the container when replacing the liquid
- Autoclavable container

#### Technical data

Weight:	2 kg	Frequency:	50/60 Hz
Output:	35 W	Rotation:	1,700 U/min
Voltage:	230 V		

Article description	REF
Device with container, 50 g polishing needles (ø 0.6 mm) 1 liter of liquid and 1 magnet	401 136
50 g polishing needles, nickel-free stainless steel ø 0.6 mm for dentures	304 014
Speedo-Clean Liquid, 1 liter	554 106
Container with lid (to collect the needles)	355 419
Magnet separately	304 012



## Protho Clean®

### Fully synthetic cleaning product for cleansing and high-gloss polish of acrylic artificial dentition

- Esthetically upgrades the presentation of your prosthetic works
- Removes polishing agent and monomer residues from prosthetic work
- Spray on and leave for a short while before wiping off with a soft cloth
- Pleasant flavor: mint

Article description	Content	REF
Protho Clean	75 ml	554 220





## Airsonic® Mini Sandblaster

### Handy sandblaster

- For roughening of bonding surfaces of crowns, bridges, brackets, posts, etc.
- Thoroughly roughened bonding surfaces for optimal bonding of various materials
- Ideal for all metals and ceramics
- Also suitable for the removal of cement residues from crowns and bridges

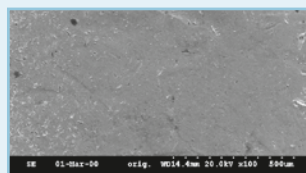

Before sandblasting

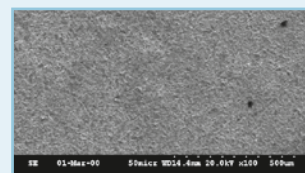

After sandblasting

Article description	REF
Sandblaster, standard nozzle 60° and 20 g powder (50 µm)	401 080
Nozzle 60° separately	401 086

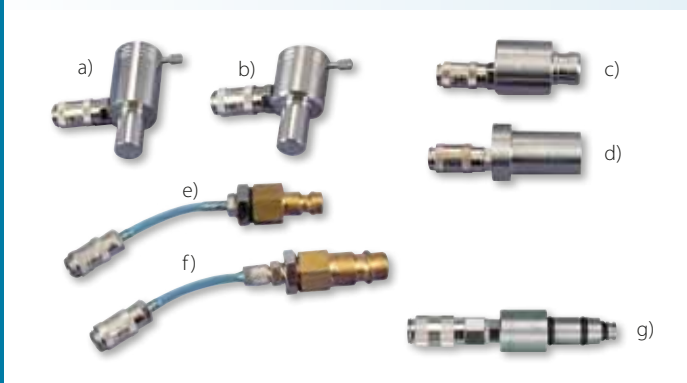

## Airsonic® Adapters

Article description	REF
a) Adapter K for direct connecting to Kavo turbine	401 084
b) Adapter S for direct connecting to Sirona titan turbine	401 089
c) Connection to W+H Rotoquick	401 077
d) Bien Air Unifix	401 076
e) Connection to EMS-Box	401 090
f) Connection to lab coupling	401 091
g) Adapter for direct connecting to NSK	401 075



## Airsonic® Absorbo Box®

### Handy absorber box

- Portable absorber box – the abraded material remains in the box and is completely collected in the filter
- Very low-noise and high-performance device
- Solid and durable design
- Problem-free cleaning by removable filter
- No separate aspiration system required
- Ideal for practice and practice laboratory in combination with the Airsonic mini sandblaster (REF 401 080)

#### Technical Data:

Size (W x H x D): 35.6 cm x 22 cm x 37 cm

Weight: only 2.8 kg

Equipment available on request

Article description	REF
Airsonic Absorbo Box	401 082
Replacement filter separately	401 092
Replacement pane available on request	



## Airsonic® Alu-Oxyd

### AL<sub>2</sub>O<sub>3</sub> powder for sandblasting

Article description	Content	REF
Airsonic Alu-Oxide, 50 µm	500 g	605 084
Airsonic Alu-Oxide, 90 µm	500 g	605 086

## Orbatec® Prophy

### Prophylaxis straight hand pieces and contra-angles

- For prophy cups and brushes with screw and button fixation
- From 0–5,000 rpm
- Fit any standard micro motor with plane shaft
- Autoclavable



Article description	REF
WST PK (button fixed)	452 152
WST PS (screw fixed)	452 153
HST R 4:1	452 159

For Prophy-Angles see page 43.

## Orbatec®

### Standard hand pieces and contra-angles

- Fit any standard micro motor with plane shaft
- Autoclavable

Article description	REF
WST (30 BL) 30.000 U/min	452 150
HST (30 A) 40.000 U/min	452 158



Button fixation

Screw fixation

HST R



WST

HST

## Orbatec® Holder

### Drip off holder for hand-pieces

- For surplus oil collection
- Holds 8 hand or contra angle pieces
- Size: Height approx. 12.3 cm, ø 12.1 cm
- Autoclavable



Article description	REF
Orbatec Holder incl. 5 drip pads	452 160
Refill pack with 20 drip pads	452 161







## Mara Expert Charcoal Plus Sensitive

*Special toothpaste: natural whiteness and protection for sensitive teeth*

- Trendy product with charcoal plus formula
- With double-acting formula: black stripe – charcoal formula for naturally white teeth, white stripe – protection against pain sensitivity
- Calming of the tooth nerve with potassium ions
- Fresh and mild mint aroma for fresh breath
- Sodium fluoride 1.450 ppm



Article description	Content	REF
Mara Expert Charcoal Plus Sensitive	75 ml	MARAAK02

## Mara Expert Interdental Brushes "Premium Line"

- Soft premium bristles coated with fluoride, CHX and mint flavour
- Plastic-coated, medical stainless steel wire
- Hygienic protective cap, also serves as handle extension
- Soft handle for a secure hold, colour-coded in accordance with ISO norm



Article description	ISO	Ø Wire	Passage Hole Diameter	Content	REF
Mara Expert Interdental Brush, pink	ISO 0 (extra fine)	0.4 mm	< 0.6 mm	100 pcs.	MARAIDZ0
Mara Expert Interdental Brush, orange	ISO 1 (fine)	0.45 mm	0.7 – 0.8 mm	100 pcs.	MARAIDZ1
Mara Expert Interdental Brush, red	ISO 2 (medium fine)	0.5 mm	0.9 – 1.0 mm	100 pcs.	MARAIDZ2
Mara Expert Interdental Brush, blue	ISO 3	0.6 mm	1.1 – 1.2 mm	100 pcs.	MARAIDZ3
Mara Expert Interdental Brush, yellow	ISO 4	0.7 mm	1.3 – 1.5 mm	100 pcs.	MARAIDZ4
Mara Expert Interdental Brush, green	ISO 5	0.8 mm	1.6 – 1.8 mm	100 pcs.	MARAIDZ5

## Mara Expert Floss sticks

- Dental floss sticks with special coating: fluoride, xylitol, CHX and mint
- Extra strong, tear-resistant dental floss
- With toothpick function
- Ideal for on the go (in a zip bag)

Article description	Content	REF
Mara Expert Floss sticks	40 pcs.	MARAZS01



# How to Prevent Microleakage in Implants?

Author: Dr. med. dent. Deborah Horch, Düsseldorf, Germany



**Dr. med. dent. Deborah Horch**

- 2006 – 2011 Study of dentistry at Münster University, Germany
- 2012 – 2014 Dental Practice, Korschenbroich
- 2014 – 2016 Education as oral surgeon, OMFS Clinic Essen
- 2015 Completion Curriculum Implantology
- 2016 – 2018 Oral surgeon, MKG am Wasserturm, Dr. med. Dr. med. dent. Schmüdderich, Meerbusch, Germany
- 2018 Oral and maxillofacial surgeon

Every colleague working in implantology is familiar with the unpleasant odor when opening the implant body (Fig. 1). The involved bacterial colonization is immanent in all multipart implants, however, it can be prevented by adequate treatment methods. In my practice I would notice a putrid smell when making the implant prosthetics. Usually, this smell occurs upon removal of the gingiva former after a few days and naturally when opening the implant bodies.

This is unpleasant for dentist and patient alike. Moreover, it is no great pleasure for the dentist to explain to the patient that implants are colonized with bacteria and consequently do stink. Prevention of bacterial colo-

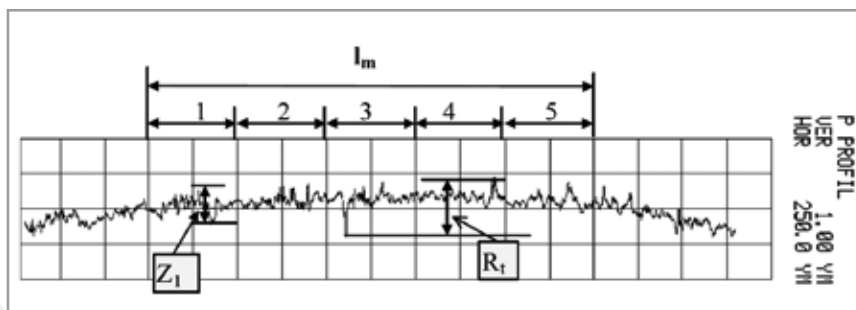

Fig. 2: A surface roughness of more than 1 µm remains in titanium even in case of optimal treatment<sup>(2)</sup>

nization is absolutely desirable for the sake of personal comfort, not to mention medical considerations. When looking for reason and solution, I first contacted the implant makers to get information why implants simply seem to be untight. However, from their side, there is a great silence regarding microleakage and the involved odor development. On the Internet, you see impressive high gloss photos promising an optimal implant fitting, on the other hand, you will not find any information on gap formation between abutment and implant body.

Reality, however, shows that multipart implants always feature gaps with an active liquid and germ exchange from the implant body to the in- and outside, which has been proved as microleakage in many current studies. This is most plausible when looking at an implant construction in more detail.<sup>(1)</sup> Nearly any modern two-piece implant system is made from titanium

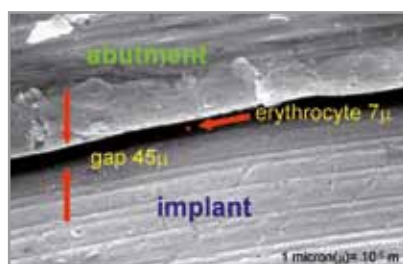

Fig. 3: Size of an erythrocyte and implant-abutment-gap relation (magnification 1:750).



Fig. 1: Putrid odor development due to bacterial colonization

and zircon (zirconium). Even with the cleanest polish and most modern production techniques, the surfaces still show deviations of at least 1 micrometer (Fig. 2). This seems to be insignificant. For germs, however, they are large inlets. Manufacture tolerances may also affect these optimal values considerably. Even in case of optimal manufacture, dimensions “equal upon equal” might not fit as the parts have to be stucked into one another. Also conical implants cannot be shut hermetically. In case the abutment is additionally screwed, new gaps will develop in the thread. Capillary forces contribute by providing an active exchange between implant interior and the germ-loaded oral cavity. Mastication once more enlarges the gap considerably, as titanium implants are no rigid bodies reacting elastically under function as shown in Fig. 4 respectively table 1: namely by up to 15 micrometers for Astra or Straumann.



Continuation:

<https://www.hagerwerken.de/wp-content/uploads/2019/12/GapSeal-Horch-GB.pdf>

# The Real Aid for Back Pain

Author: Dr. med. dent. Deborah Horch, Düsseldorf, Germany



**Dr. med. dent. Deborah Horch**

- 2006 – 2011 Study of dentistry at Münster University, Germany
- 2012-2014 Dental Practice, Korschenbroich
- Since 2014 education as oral surgeon, OMFS Clinic Essen
- Completion Curriculum Implantology

the lumbar spine is straightened and the body weight is carried by the spine structures. The muscles relax, however, the intradiscal pressure is increased. In plain language – you adopt an unhealthy sitting position.

Moreover, the Bambach saddle seat supports blood circulation of the tissue and the musculature. Furthermore, long and undynamic sitting causes congestions in the venous and lymphatic system leading to a pressure increase, which in the long run may end in an increased activity of the pain receptors. Long sitting decreases HDL (high density lipoproteins) and rises the cholesterol level thus promoting the development of arteriosclerosis respectively thrombosis in the long term (van der Ploeg et al, 2012). For this reason, the working place should be designed as ergonomically as possible in order to guarantee an optimally healthy working position.

The Bambach saddle seat is a clever solution to this problem and in addition it is very practical in handling. The seat is not only adjustable in height, but also the inclination angle can be adjusted individually. By this, the seat keeps the pelvis tilted forward without stress on the knees by the body weight thus avoiding an unhealthy protective position. A sitting position with the pelvis tilted forward provokes the upright posture of the natural lumbar spine curvature thus reducing the pressure to the vertebral disk. Studies with children and rehabilitation patients prove that sitting with the pelvis tilted forward facilitates the function of the upper extremities. A dental study (Ganadavadi et al, 2005) reveals that the failure rate in a sitting position with bent over pelvis is reduced, simultaneously skillfulness is increased.

Continuation:

[www.hagerwerken.de/wp-content/uploads/2019/09/Bambach-Horch-0819.pdf](http://www.hagerwerken.de/wp-content/uploads/2019/09/Bambach-Horch-0819.pdf)

*The work of a dental professional requires a lot of concentration and precision. The limited working area of the mouth often forces us into an unnatural and stiff working position. The Bambach® saddle seat (Hager & Werken) has recognized and solved this problem.*

After extensive and difficult treatments, I used to suffer from back pain resulting from the natural protective function of the body against the unnatural sitting position. Did you know that a bent over sitting position causes a pressure to the intervertebral disk equivalent to carrying heavy weights? In a sitting position, the requirements of our musculoskeletal system do change considerably. We principally try to adopt a (protective) position by tilting back of the pelvis for compensation of the femoral musculature tension. By this position,



\* seats of other manufacturers without this curvature



**Tel. + 49 (203) 99269-0**

**Fax + 49 (203) 299283**

*Dental practice:* \_\_\_\_\_

*Contact person:* \_\_\_\_\_

*Phone:* \_\_\_\_\_ *Fax:* \_\_\_\_\_

*E-Mail:* \_\_\_\_\_ *URL: www.* \_\_\_\_\_

*Address:* \_\_\_\_\_ *Country:* \_\_\_\_\_

*Dental dealer:* \_\_\_\_\_

*town* (important for delivery): \_\_\_\_\_

Quantity	REF	Article

Quantity	REF	Article

*Please send me information regarding the following products:* \_\_\_\_\_

Hager & Werken GmbH & Co. KG  
 Ackerstraße 1 · 47269 Duisburg, Germany  
 Telephon +49 (203) 99269-0  
 Fax +49 (203) 299283  
 E-Mail info@hagerwerken.de  
 Internet www.hagerwerken.de

Subject to changes and variations.  
 Our terms of delivery and our payment  
 terms apply exclusively.







# Your partner for dental specialities, ideas and service.



Häger & Werken GmbH & Co. KG  
Ackerstraße 1, 47269 Duisburg, Germany  
Tel. +49 (203) 99269-0  
Fax +49 (203) 299283  
E-Mail [info@hagerwerken.de](mailto:info@hagerwerken.de)  
Internet [www.hagerwerken.de](http://www.hagerwerken.de)

Please see our general terms and conditions  
at [www.hagerwerken.de](http://www.hagerwerken.de)



Follow us



Follow us